



MOTION  
● SPOT

Creating beautifully accessible  
solutions for the home.

# Welcome to Motionspot

•• *Motionspot is an award-winning design specialist creating beautiful accessible solutions and supplying innovative products that can positively change lives.* ••

## Understanding your needs – our story

Motionspot was launched in 2012 by Ed Warner and was inspired after friend and Co-founder James Taylor was paralysed in a diving accident in 2005.

Ed and James set out to find the solution and launched Motionspot with the aim to design and supply beautiful bathrooms that deliver the necessary access for people without compromising on aesthetics.

James returned home from his stay in hospital to find his adapted flat looking more like a care facility than a home. He knew he wanted something different, but finding a stylish bathroom that had the required support without looking like a hospital room proved difficult.

Since launching, the Motionspot team has helped hundreds of people enjoy their homes to the fullest by creating rooms that promote independence and wellbeing.



James (left) and Ed in one of our bathrooms.

## Contents

- 04 Creating your dream accessible bathroom
- 06 How we work with you
- 07 Design service
- 08 Choosing the right products for you

## Products

- 10 Accessible shower areas
- 11 Shower floors and grates
- 11 Shower screens
- 14 Shower controls
- 15 Shower heads
- 16 Shower riser rails
- 17 Shower seats
- 18 Wall hung and back to wall toilets
- 20 Flush plates
- 21 Wash and dry toilets
- 22 Close coupled toilets
- 23 Towel rails
- 23 Mirrors and storage
- 24 Basins
- 26 Taps
- 28 Fixed and removable support bars and rails

## Your style

- 30 Your style, your way – From floors to walls
- 31 Classic
- 32 Simply Elegant
- 33 Contemporary Geometric
- 34 Luxury Linear
- 35 Reassuring Comfort

T +44 (0)203 7355139  
 E [team@motionspot.co.uk](mailto:team@motionspot.co.uk)  
 W [motionspot.co.uk](http://motionspot.co.uk)



## Creating your dream accessible bathroom

Motionspot will work with you to create the perfect bathroom which meets all your access needs both now and in the future. We will guide you through the process of choosing the products that suit you, your family and the space available.

### Info



Our design specialists only work on accessible design projects, so are truly experts in accessible design principles. The team works across both residential and commercial projects including some of the finest accessible hotels, retirement villages and offices in the UK. This expertise enables us to offer a wider perspective and unique ideas for the accessible design project within your home.

### Fact



Motionspot uses principles from disability design regulations (Part M and BS8300) along with input from Occupational Therapists and best practice to produce the best designs given the space and information available.



### Small or large – every accessible project counts

Whether you have a small or large bathroom project, you will receive the same high-quality service from the Motionspot team from start to finish of your project.

# How we work with you – an overview

1

## Personal review

To help us plan your accessible bathroom, we spend time with you to understand your specific needs and requirements.

We will ask you a variety of questions on how you use and move around your bathroom space and what your style preferences are. We will also ask about the dimensions of the space.

We can complete this personal review over the phone, via email or in person.

2

## Free quote

Following your initial review, we will provide you with a free bespoke product quotation and visuals for all the products we have recommended. This will also give you the overall cost of your bathroom products.



3

## Supply and free delivery

Once ordered, we will carefully package and deliver all products to your home or to your contractor free of charge on all orders above £100.



4

## Installation

Whilst we don't carry out the installation ourselves, we can recommend builders and installers local to you. We will be on hand to answer any questions that may arise during the fit out.

5

## Completion

We will be on hand to offer support and advice on the use of all of your products post installation. All products are under warranty for 12-36 months.

## Optional design services

You can also choose one of our accessible design packages:

### Design Package

Our design team will work with you to plan a bathroom layout which maximises access within your bathroom. We will provide detailed floor plans and elevations showing the exact location and positioning of products to suit you.

Learn more here >

### Premier Design Package

Your dedicated design team will provide complete technical and interior design advice. We will meet you in your home and create a proposal which includes all plans, elevations, interior finishes and a review of the final plans by one of our Occupational Therapists.



# We can help you create a beautifully accessible home with the following design services

## Design Package

Offering specialist technical design advice to create a perfectly designed accessible bathroom.

### Included within the package:

- Dedicated client account manager.
- Detailed design drawings created to maximise access within your bathroom.
- Mood board example of products and finishes.
- Scaled floor plans and elevation drawings for your installer to follow.
- Remote installer support during installation.

## Premier Design Package

A dedicated account manager and design team will work with you to create a beautiful accessible bathroom with comprehensive technical and interior design support.

### Included within the package:

- Dedicated client account manager and designer.
- Site visit to measure and survey your bathroom.
- Design meeting to discuss interior design requirements and style preferences.
- Detailed design drawings that maximise access within your bathroom.
- Comprehensive interior design proposal and 3D render design.
- Scaled floor plans and elevation drawings suitable for installer to follow.
- Occupational Therapist review of the recommended plans.
- Remote installer support during installation.

## Project Management

From start to finish, a complete project management service for construction of your accessible bathroom.

### Included within the package:

- Preparation of builder/installer tender documents.
- Management of construction tenders through to contractor appointment and cost agreements.
- Site meetings with the contractor.
- On-going technical support throughout the project build.
- Snagging meeting.
- On-site project sign off.

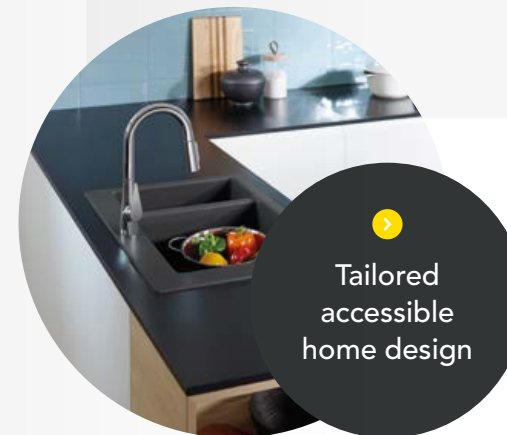

Tailored accessible home design

If you want to improve access within other rooms in your home, Motionspot also offers a tailored access audit and interior design service for all areas of the home including entrances, bedrooms, kitchens, and living areas.

For further information and costs on all Motionspot design services please contact the team on +44 (0)203 7355139.



## Choosing the right products for you

Choosing the right products that meet your needs is an important decision. We're committed to ensuring every product in our range covers all access requirements to make certain your bathroom is safe and functional, but without compromising on style or beauty.

Motionspot has hundreds of accessible bathroom fixtures and fittings from essential sanitary ware such as toilets and basins, through to bespoke mirrors and drying benches that can make life a little more comfortable.

### Pricing Guide

Each bathroom is individual and requires products in different sizes and finishes, so we don't show indicative prices. Whatever your budget or style, we will work with you to create the accessible bathroom of your dreams.

#### Info



It's important to note that some products require more building work than others, so it is worth considering how much building work you are happy to undertake for your new bathroom. Your Motionspot account manager will walk you through every step of the installation requirements for each individual product to help guide this decision.

#### Fact



#### VAT Exemption

Did you know that some home renovations and adaptations can qualify for VAT exemption? Your Motionspot account manager can discuss whether your project would qualify.



### Our product selection

The following pages give you an indication of the types of products and styles available. There are hundreds of options available, all of which come in a variety of different sizes and finishes.





# Accessible shower areas

Safety, accessibility and comfort are always in the forefront of our minds when designing and recommending accessible showers. For walk-in showers, wet-rooms or roll-in showers, we will only design the area with completely level floors as even the smallest lip can become a trip-hazard or an obstruction for wheelchair or commode users.

**Fact**



Underfloor heating is great for drying shower areas after use and provides greater warmth within the room.

## Shower floor systems – how does a level access shower floor work?

We are often asked how level access showers work, as there is no obvious shower tray installed! The flooring of a level access shower is generally a continuation of the rest of the floor in tile or vinyl, so there is nothing to step in or out of.

Beneath the floor surface sits a 22mm thick contoured deck that gives a gradient of 1:40 so water can run away to the floor drain. A membrane is then laid down on top, before the final tiles or vinyl flooring is laid, all of which guarantees the waterproof properties of the shower.

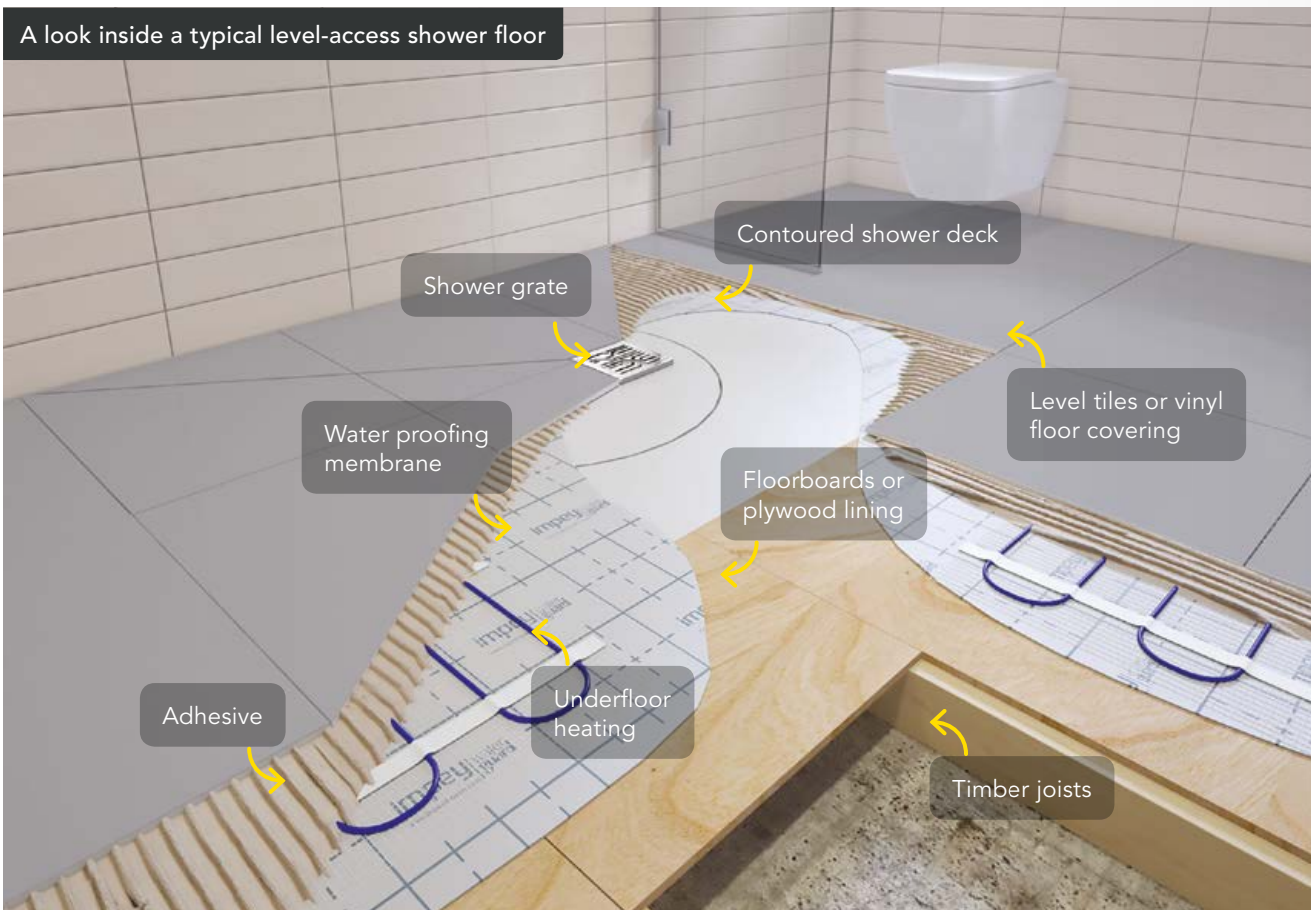

# Shower floor grates

Depending on whether you choose a tiled or vinyl shower floor, the water will drain via a shower grate. All options are available in a variety of shapes and finishes.



- 1. Linear tile grate
- 2. Stainless steel linear grate
- 3. Square shower grate

# Shower screens

Level access walk-in showers can be enhanced with beautiful and flexible shower screens that offer different folding options to provide greater circulation space and user experience.

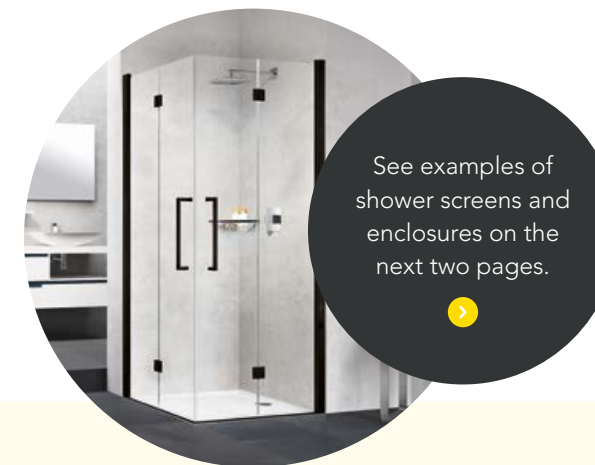

See examples of shower screens and enclosures on the next two pages.

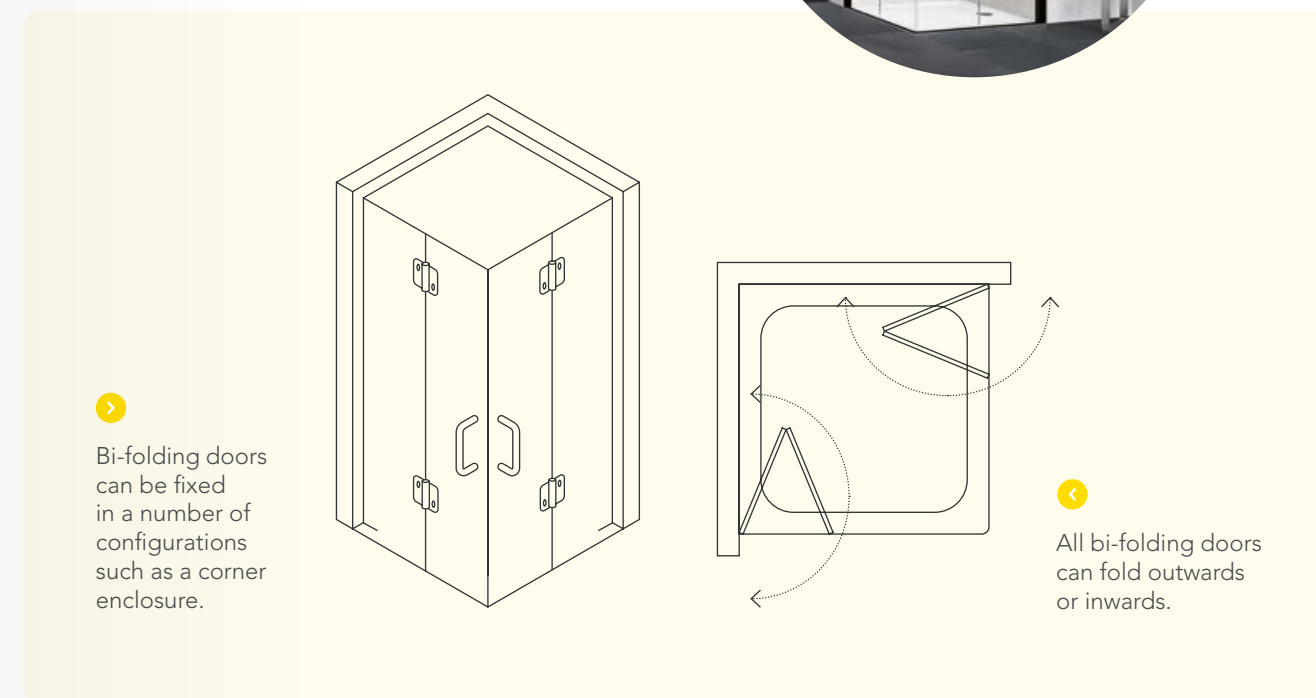



# Shower screens

### Accessibility features

- **Bi-folding screens** are ideal where maximising circulation space is a necessity.
- **A fixed screen with a pivoting panel** can offer greater circulation space when entering the shower.
- **Traditional shower curtains** are weighted to avoid cling and feature in-built anti-bacterial properties.

### Options and info

- Motionspot accessible shower screens and enclosures are made with toughened safety glass and floor seals to prevent water escape.
- Screens are available in widths of 600mm to 1200mm and are 2000mm high.
- Left and right-hand opening options.
- Made-to-measure screens can be manufactured on request.
- Self-cleaning properties within the glass provide the perfect solution to limescale build-up.

Screens are available as:

- **Single bi-fold**, folding back on itself or against a wall.
- **Corner enclosure**, typically on two sides from a wall to create a fully enclosed shower area.
- **In-line shower screen** which can enclose the shower area from opposite walls.
- **Fixed shower screen with pivot panels** can also act as a water deflector.
- **Split level shower screen** can be incredibly useful if carer washing is required.



1. Shower curtain  
 2. Bi-folding enclosure in matt black  
 3. In-line bi-folding enclosure  
 4. Split level screen  
 5. Bi-folding corner enclosure in chrome  
 6. Fixed screen with pivot panel



## Shower controls

Creating an accessible shower area that gives a luxury showering experience for all can be possible without compromising on style.

### Accessibility features

- All Motionspot shower valves feature easy to operate lever handles avoiding any fiddly twist or turning actions.
- All come equipped with thermostatic controls or temperature limiters to avoid the potential for scalds.

### Options and info

- Different shower valves are suitable for high and low pressure water systems.
- **Exposed shower valves** are easy to install as the body of the shower control sits exposed on the bathroom wall.
- **Concealed shower valves** are positioned flush with the shower wall with pipework hidden behind the wall.
- **Electric showers** offer a good solution when only a cold-water feed is available.
- **Digital showers** offer the ability to remotely activate the shower from a wall mounted button, phone or tablet and are ideal for ensuring the perfect water temperature before entering the shower.

1. Modern concealed shower valve
2. Exposed shower mixer
3. Electric shower
4. Push button concealed shower valve
5. Digital shower
6. Heritage concealed shower valve
7. Classic exposed shower valve
8. Concealed shower valve with crosshead

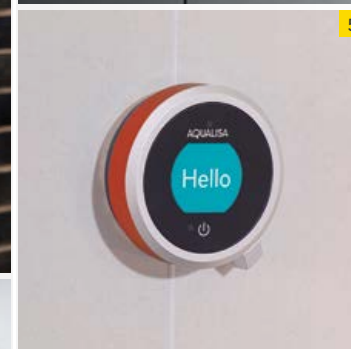

## Shower heads



### Options and info

Dependent on your chosen shower valve (and the number of outlets available), we would recommend:

- For exposed shower valves a **handheld shower head** on a riser rail.
- For concealed valves with dual outlets, an additional **rainwater overhead shower head** can be added as a feature in any accessible shower area.

1. Rainwater overhead shower and handheld with extended hose



## Riser rails

### Accessibility features

- For peace of mind whilst standing, transferring or moving within the shower area, each of our riser rails can support up to 150kg, avoiding the need for multiple grab rails within the shower area.
- The height of the shower head can be easily adjusted with one hand avoiding any fiddly adjustment.
- For additional support, the horizontal bar on the 'L' shaped rail can be ideally positioned to offer additional support around the bathroom.

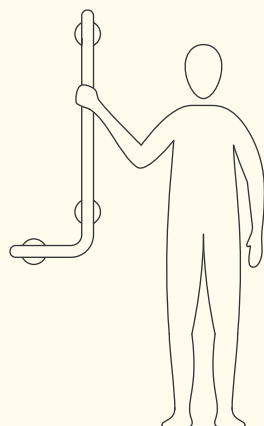

### Options and info

- Either left or right-hand horizontal bars providing comfortable support within the shower area.

1. 'T' shaped riser rail
2. 'L' shaped corner wrap riser rail
3. 'L' shaped riser rail
4. Vertical riser rail



## Shower seats

With a range of designs and finishes to suit all mobility requirements, Motionspot's wall mounted shower seats are stylish, comfortable and offer a range of postural support options.

With the ability to hinge against the wall, or be removed when not required, the seats are an excellent addition to an accessible shower room. All seats are supplied with specialist fixings to ensure safety and a secure fitting for up to 150kg of support.

### Accessibility features

- Can be mounted at the perfect height for the user.
- Can provide up to 150kg of support.
- Offers support in the shower area for anyone requiring greater core or postural support in the shower.
- Horseshoe seats available.

### Options and info

- With and without backrest options available.
- Anthracite grey, white and black versions available.
- Removable options available.
- Padded options available.

1. Soft touch shower seat
2. Modern hinged seat
3. Removable shower seat with back support and arms
4. Wall mounted shower seats
5. Removable shower seat with back rest

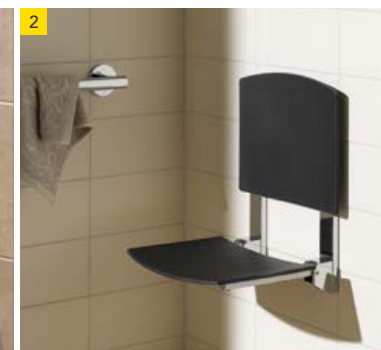



## Toilets

The importance of deciding the right height and projection for your toilet should not be underestimated. Dependent on the requirements of each client, Motionspot recommends an elevated toilet seat between 450-480mm in height from the floor. The projection of the toilet is also important for anyone transferring from a wheelchair or needing to use a commode chair. Increasing the height of the toilet can also help with anyone suffering from joint pain.

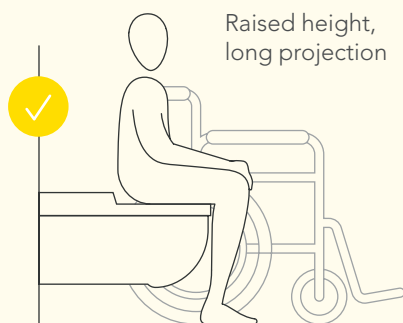
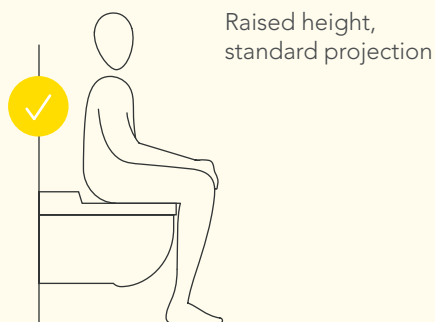
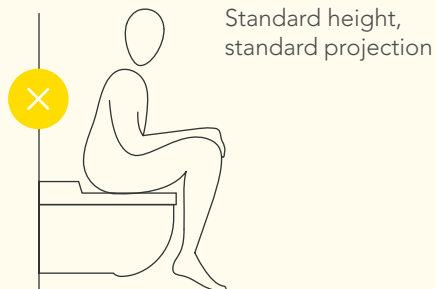

## Wall hung and Back to wall toilets

### Accessibility features

#### Wall hung

- Wall hung toilets can be mounted at the ideal height and are available in both long and short projection options.
- Good for transfer from a wheelchair or for use with a wheelchair commode.
- All wall hung and back to wall toilets can support up to 400kg.
- The toilets are easy to clean underneath and can create the illusion of greater space in the room.

#### Back to wall

- Back to wall toilets offer reassurance to anyone preferring the toilet to be fixed to the floor.
- Available in both long and short projection options.
- Standard (420mm) and comfort (450-480mm) heights available.

### Options and info

- A range of traditional and modern styles including wash and dry versions are available
- Lighting can be added underneath the toilet to improve navigation to the toilet at night.

1. Long projection wall hung toilet
2. Short projection wall hung toilet
3. Classic back to wall toilet
4. Modern back to wall toilet



## Flush plates

Flush plates are designed for wall hung and back to wall toilets where the flush is part of a concealed cistern. There are a variety of styles and options available that can suit everyone's access needs and individual style preferences.

### Accessibility features

- Ease of use at the slightest touch. All Motionspot flushes are simple to use and contain either single or dual flush options.
- **Sensor operated** flush plates are perfect for anyone finding it difficult to reach or push a flush button.
- **Spatula levers** can be operated with an elbow from a seated position.
- **Raised push buttons** are positioned on the top of a cistern or concealed unit and can be easily operated with a clenched hand, or even an elbow.

### Options and info

- Two flush options offer a shorter and longer flush for water economy.
- Different finishes and colour options available from chrome to glass effects to suit all budgets.

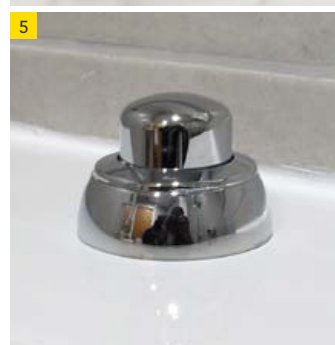
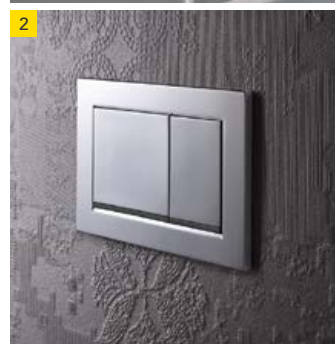

1. Rectangular dual flush plate
2. Square dual flush plate
3. Sensor flush plate
4. Circular dual flush plate
5. Raised push button for close coupled toilet
6. Spatula flush for close coupled toilet

## Wash and dry toilets

There are a number of wash and dry toilets available covering a variety of budgets and styles. Advances in technology offer users greater independence and less reliance on carer support.

### Accessibility features

- Raised height (480mm) and standard height (420mm) models available.

### Options and info

- Available in long or short projections.
- Wash and dry toilets feature a variety of options which can support independence, such as a heated seat, lid motion detector for automated opening and closing, remote control, wash and dry functions and lighting.



1. Close coupled wash & dry toilet
2. Wall hung wash & dry toilet



## Close coupled toilets

### Accessibility features

- Raised height (480mm) and standard height (420mm) models are available.
- Accessible lever or button operated flush (no fiddly recessed flush!).
- The cistern can also be used for storage space.

### Options and info

- Easy to install and maintain.
- Available in long or short projections to suit individual requirements.
- Traditional and modern styles available.



1. Modern close coupled toilet  
2. Classic close coupled toilet

## Towel rails

The finishing touches in the bathroom are important and it's often the little things that make the biggest difference. If you've ever been frustrated by towels being positioned too far away from the walk-in shower, or toilet rolls being out of reach, Motionspot has a range of products which have been designed to make the most of your accessible bathroom.

1. Modern towel rail
2. Classic towel rail



## Mirrors and storage

Combining storage options or for optimal light at the wash basin, there is a choice of mirrors to suit your bathroom style.

### Accessibility features

- Fully lit mirrors improve visibility and help to avoid casting shadows whilst at the wash basin – an important factor for anyone with a sight impairment or dementia.
- Shaving mirrors are installed with extendable hinges. These mirrors can be pulled out towards anyone seated and provide better clarity for shaving or makeup application.

### Options and info

- A variety of sizes and styles available.
- Mirror cabinets are available with internal lights and integrated storage shelves.

1. Mirror cabinet
2. Back lit mirror
3. Wall mounted storage unit





# Basins

Many of the basins on the market have floor standing pedestals which can obstruct access to the basin from a seated position or a wheelchair. All Motionspot accessible basins are designed to be either wall hung with space underneath, inset (placed onto a counter top), or wall mounted with a semi-pedestal. Importantly, we ensure the bottle trap under the basin is fully insulated so there are no chances of burns from hot pipework.

We appreciate that storage is important in the bathroom and the natural place for a vanity unit is below the basin. We will consider the design of your space to offer alternative storage options that work for you.

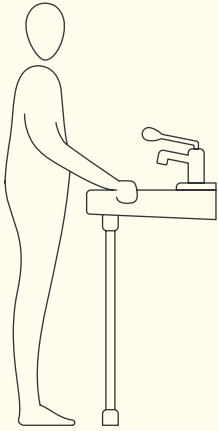

Basins can offer support whilst standing.

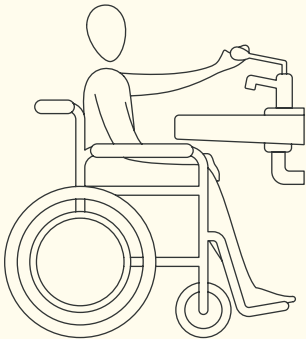

Wall hung basins can be placed at the ideal height for wheelchair access.



### Accessibility features

- All Motionspot basins can be mounted at the ideal height for the user and are designed to ensure comfort when seated or standing.
- The benefit of clear access underneath ensures anyone using a wheelchair or commode can get closer to the taps and basin.
- Semi-pedestal basins conceal the waste pipe.
- Some basins feature additional surface area which can be useful for storage.

### Options and info

- All basins come with or without a choice of tap holes to suit all tap options.
- All basins come in a variety of sizes suitable for cloakrooms through to large family bathrooms.

1. Wall mounted basin with hand grips
2. Classic basin with optional frame
3. Wall mounted basin with surface storage space
4. Curved wall mounted basin
5. Mini hand rinse basin
6. Wall mounted basin with semi-pedestal
7. Rectangular wall mounted basin
8. Modern countertop basin



# Taps

Our taps offer the functionality you need whatever your requirements: from levers which move with the lightest touch, sensor taps responding to a wave, or thermostatic controls designed to regulate temperature and avoid potential scalds, there is a solution for all access and style requirements.



## Accessibility features

- All Motionspot taps are easy to operate by anyone struggling to twist or turn easily.
- Lever taps can be operated by a slight touch from a hand, fist, arm or elbow. This allows for the temperature to be easily controlled.
- Either temperature limiters or thermostatic mixing valves can be added to all of our taps to control the maximum temperature for anyone with sensitive skin or prone to burns.
- Sensor taps are easy to use with motion activation; the built-in limiter sets flow to run from approximately 10-30 seconds at a time.
- Wall mounted mixer taps allow for a clean minimal look, but can require additional plumbing to conceal pipework. They also require the user to be able to reach over the width of the basin.



## Options and info

- Chrome is still the most popular choice, but with a wide variety of styles and finishes available, the final style can be uniquely yours. Across the tap ranges, different finishes are available from chrome to brushed satin, antique gold, rose gold and black.
- Matching shower valves are available across the Motionspot bathroom ranges.



1. Citterio single lever basin mixer (black chrome)
2. Talis S single lever swan neck basin mixer
3. MPro wall mounted basin mixer
4. Metropolis 3-hole basin mixer
5. Metropol wall mounted basin mixer
6. Metris single lever basin mixer
7. Design single lever basin mixer
8. Waldorf 3-hole basin mixer
9. Talis classic single lever mixer
10. Montreux single lever basin mixer
11. Kensington 3-hole basin mixer
12. Carlton 3-hole basin mixer



# Fixed and removable grab bars and rails

Motionspot's unique range of grab bars, rails and shower seats cover every access requirement to ensure the bathroom is safe and functional.

## Accessibility features

### Fixed grab bar

- Grab bars are fixed to the wall and offer additional reassurance and support when standing or moving around the bathroom.
- Can be helpful when positioned at the toilet and in the shower area.
- Offering up to 130kg of support.

### Hinged grab rail

- The rail will hinge back to the wall when not in use to improve room space and circulation.
- Offering up to 130kg of support.
- Removable versions available.
- Helpful when positioned by the toilet and in the shower area.
- All have an option for toilet roll holders to be attached to the hinged rail to prevent having to twist and turn to reach toilet roll.

## Options and info

- Available in a variety of shapes and bespoke finishes.
- Wall fixed grab bars are available in sizes from 300mm to 900mm.
- Hinged grab rails are available in sizes from 600mm to 850mm.
- Grab bars and rails can be installed to suit the style and aesthetics of the room, from wooden, chrome, steel, coloured or even special finishes, such as rose gold, copper or matt effect.



## Info How removable grab rails work



## Accessibility features

### Removable grab bars and rails

- Installing removable grab rails offers the ability to future-proof the home with supports and equipment that can be introduced when required over time.
- Offers a discreet support function which can be helpful when positioned at the toilet and in the shower area.
- Offering up to 130kg of support.

1. 'L' shaped grab bar (range of colours available)
2. Removable hinged grab rail chrome
3. Hinged support rail with comfort grip
4. Hinged grab rail stainless steel
5. Oak hinged & fixed support bars
6. Hinged grab rail chrome finish
7. Hinged dual support grab rail



## Your style, your way – from floors to walls

Our in-house interior designers are delighted to help you transform your bathroom from a space which simply meets your access needs, into one of your dreams.

All of our proposals can include recommendations on flooring and wall finishes for complete bathroom projects. Tile and vinyl samples can be sent out on request and we are happy to talk through and make recommendations on finishes that suit your preferred style and requirements.



All our slip resistant floors comply with HSE guidelines to prevent slips and trips



### Safety and comfort

The finishing touches to any renovation can be the most exciting part of a bathroom project, however we are often asked about the potential dangers of falling in a bathroom or walk-in shower area. Safety and comfort is always at the forefront of our design rationale and all our slip resistant shower floors comply with HSE guidelines to prevent slips and trips in the bathroom.

### Slip resistance

If the tiled look is preferred to vinyl flooring, Motionspot always specifies slip resistant tiles. Tile slip resistance is measured by the industry PTV (Pendulum Test Value) and offers the safest option for users. The minimum slip resistance value of 36+ is recommended in all commercial environments, but we would also recommend this within the home for safety.

### Colour contrast

Thinking about the colour contrast between the floor and walls is also an important consideration when choosing your flooring and is important for anyone living with a sight impairment or dementia. Our team will advise on this when designing the right bathroom for you.



## Classic

Mixing traditional sanitary ware with contemporary finishes can transform bathrooms into modern, luxury environments still in keeping with the period features of your home.



### Style inspiration

Our Classic styling mixes non-slip patterned floor tiles with a Victorian inspired close-coupled toilet, basin and radiator for a warm vintage feel. This style can also work very well with rich heritage tones such as deep greens and sea blues.



### Products

- 1 Victorian close-coupled toilet with oak toilet seat.
- 2 Classic two lever mixer tap.
- 3 Bevelled metro brick wall tiles in crisp white.
- 4 Victorian style radiator.
- 5 Classic style chrome grab bar.
- 6 Small Victorian style hand rinse basin.



## Simply Elegant

Clean lines, soft colours and elegant brassware all pull together to create this calming look and feel.



### Style inspiration

Achieving a simple but very elegant style is possible by limiting your colour palette and setting tiles out symmetrically. Choosing simple products such as single lever taps and uniform sanitary ware creates a natural and comforting bathroom environment.



### Products

- 1 Matt ceramic rectangular wall tile.
- 2 Minimalist folding shower seat.
- 3 3 hole basin mixer.
- 4 Elegant close-coupled toilet.
- 5 Large slip resistant floor tiles.

## Contemporary Geometric

Laying tiles in geometric patterns is a contemporary, yet subtle way of adding interest to your bathroom. Highlights of colour on accessories bring the look together.



### Style inspiration

We have paired these contemporary coloured and wood effect tiles with a modern angular basin and wall hung toilet. However, choosing a more classic tile finish such as marble in a hexagonal shape can also add a contemporary twist.



### Products

- 1 Hexagonal wall tiles.
- 2 Modern single lever mixer tap.
- 3 Bespoke colour grab bar.
- 4 Modern long projection wall hung toilet.
- 5 Square edge wall hung basin.
- 6 Square chrome dual flush plate.
- 7 Wood effect porcelain floor tiles.



## Luxury Linear

If your style is more urban than country chic, try opting for luxury finishes or textured tiles, such as porcelain marble or stone. Mix in ingenious bathroom sanitary ware like the removable grab rail technology to give you a future proofed bathroom.



### Style inspiration

Choosing products that are beautiful in form and function means you never have to compromise on the style you love. Discreet and removable supports can be integrated into any bathroom and are available in bespoke finishes.

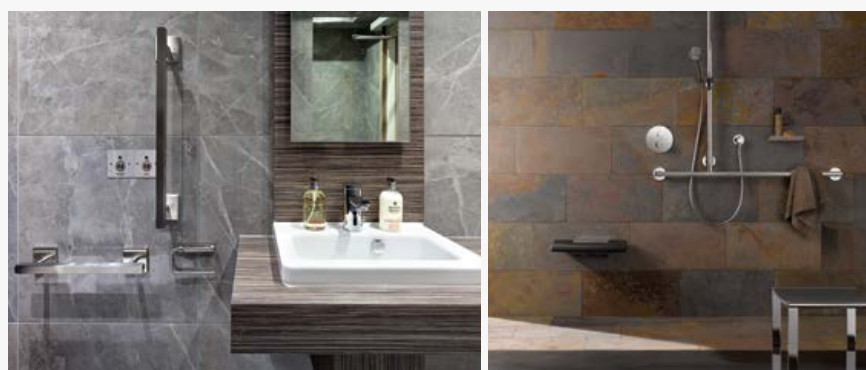

### Products

- 1 Wall hung basin with integrated hand grips.
- 2 Back to wall toilet.
- 3 Marble effect porcelain tiles.
- 4 Removable grab rail.
- 5 Thermostatic ladder radiator.

## Reassuring Comfort

For a stunning bathroom that offers reassurance for anyone with greater access requirements; opt for specialist materials that delivery safety as well as stylish features.



### Style inspiration

Minimising grout lines and opting for maximum slip resistance can be achieved with the latest advances in vinyl flooring and wall board coverings. The wide range of patterns, colours and styles opens up the options when designing a bathroom to suit your style and all can be perfectly paired with modern or traditional sanitary ware and brassware.



### Products

- 1 Stone effect wall boards.
- 2 Supportive riser rail with exposed thermostatic shower valve.
- 3 Folding shower seat.
- 4 Contemporary slate grey vinyl flooring.
- 5 Long projection close coupled toilet.





Whatever stage you are in your project,  
we are always happy to help.

---

**Visit our showroom:**

Meet the team at our accessible design studio and showroom in Twickenham, London. (By appointment)

**Call Us:**

Our design studio and showroom is open Mon-Fri 9.00 – 5.30. If office hours don't suit, please leave a message and we'll get back to you when you are available to speak.

**Meet Us:**

We have satellite accessible bathroom displays around the country where we are happy to meet you by appointment. These locations currently include Aylesbury, Hemel Hempstead, Leicestershire and Southgate with more to follow!

T +44 (0)203 7355139

E [team@motionspot.co.uk](mailto:team@motionspot.co.uk)

W [motionspot.co.uk](http://motionspot.co.uk)

🐦 [@themotionspot](https://twitter.com/themotionspot)

📷 [@motionspot](https://www.instagram.com/motionspot)