



Accessible Sports Facilities

Formerly known as
Access for Disabled People
Updated 2010 guidance

Foreword

Sport England believes that good facilities are fundamental to developing sporting opportunities for everyone, from the youngest beginner to the international class athlete. The buildings whether large or small can encourage civic pride and assist the process of revitalising deprived neighbourhoods. Facilities that are well designed built to last and well maintained are a pleasure to use and give an ample return on the time and money invested in their construction and day to day use.

Good design needs to be based on a sound understanding of such issues as the current trends and practices within individual sports, developments in the sport and leisure industry and the lessons to be learnt from previously built schemes.

Good design needs to be embraced within the earliest vision statement for a particular project and enshrined in the initial briefing stage through to the final detailed specifications and operational arrangements.



Sport England's Design Guidance Notes aim to:

- ***Increase awareness of good design in sports facilities.***
- ***Help key building professions, clients, user representatives and other stakeholders to follow best practice.***
- ***Encourage well designed sports facilities that meet the needs of sports and are a pleasure to use.***

Sport England Design Guidance Notes aim to promote a greater general understanding of overall design concepts, an appreciation of technical issues and the critical factors that need to be considered in reaching the appropriate solution for a particular project. They also advise where further information, advice and expertise may be found and point to benchmark examples.

Contents

1.0 Introduction	4	11.0 Finishes	53
<ul style="list-style-type: none">• Disabled People• The Legislative Context		<ul style="list-style-type: none">• Acoustic Requirements• Visual Requirements	
2.0 The Inclusive Design Process	8	12.0 Services	56
<ul style="list-style-type: none">• Accommodating Sports Chairs• Adapting and Improving Existing Buildings• Access Audits		<ul style="list-style-type: none">• Electrical Services• Heating• Lighting	
3.0 Arriving At The Facility	12	13.0 Management Issues	57
<ul style="list-style-type: none">• External Features		14.0 Spectator/Viewing Provision	58
4.0 The Entrance	19	15.0 Swimming Pools	60
<ul style="list-style-type: none">• Foyer/Reception Area		<ul style="list-style-type: none">• Changing Areas• Showers• Route to the Pool• Pool Design• Access to the Water• Equipment and Environment	
5.0 Internal Circulation	23	16.0 Sport-Specific Requirements	67
<ul style="list-style-type: none">• Corridors• Ramps• Stairs• Handrails• Doors• Lifts		<ul style="list-style-type: none">• Boccia• Canoeing• Fitness Suite• Goalball• Power-lifting• Sailing• Shooting	
6.0 Emergency Escape	33	17.0 Wheelchair Sports	74
<ul style="list-style-type: none">• Fire Evacuation		<ul style="list-style-type: none">• Athletics (indoor and outdoor)• Badminton• Basketball• Bowls• Cricket• Fencing• Rugby• Table Tennis• Tennis	
7.0 Changing Areas	36	18.0 Access In The Countryside	79
<ul style="list-style-type: none">• Main Changing Areas• Equipment• Unisex Accessible Changing• Showers		19.0 Conclusion	79
8.0 Toilet Provision	46	20.0 Contacts	80
<ul style="list-style-type: none">• Unisex Accessible Provision			
9.0 Social Areas	49		
<ul style="list-style-type: none">• Furniture• Served• Vending Machines			
10.0 Communication Systems	50		
<ul style="list-style-type: none">• Public Telephones• Public Address Systems• Text Phones• Induction Loops• Infrared Systems• Controls• Signs			

Contents - Tables and Figures

Tables	Description	Page
Table 1	Disabled people participate and compete in a wide range of sports	5
Table 2	Accessible car parking spaces – requirements	13
Table 3	External doors – requirements	19
Table 4	Reception area – requirements	20
Table 5	Internal doors – requirements (except accessible toilets and changing rooms)	28
Table 6	Accessible Passenger lift car & door sizes	30
Table 7	Lifts – minimum clear door width requirements	31
Table 8	Changing areas – requirements	44
Table 9	Accessible toilet provision – requirements	46
Table 10	Family / disabled cubicles - requirements	61
Table 11	Pool equipment – requirements	61
Table 12	Typical dimensions for sportschairs	74

Figures	Description	Page
Figure 1	Accessible car parking bays	13
Figure 2	Setting-down point	14
Figure 3	Designing an access route	15
Figure 4	Reception area	21
Figure 5	Reception desk - key dimensions	22
Figure 6	Internal circulation for facilities WITHOUT ‘Sports Chair Zones’.	24
Figure 7	Internal circulation for facilities WITH ‘Sports Chair Zones’.	25
Figure 8	Entrance lobby for sportshalls and tennis centres - minimum dimensions	25
Figure 9	Internal lobby for sportshalls and tennis centres - minimum dimensions	25
Figure 10	Doors – clear widths	27
Figure 11	Doors – side clearances	27
Figure 12	Doors – location of vision panels	28
Figure 13	Lift – critical details	30
Figure 14	Accessible team changing facilities	36
Figure 15	Accessible group changing facilities	37
Figure 16	Unisex accessible changing room	40
Figure 17	Unisex accessible changing room with fixed bench seat	40
Figure 18	Unisex accessible changing room with shower, WC and fixed bench seat	41
Figure 19	Unisex ‘Changing Places Facility’ (see BS8300 figure 58) where assisted change is to be provided.	42
Figure 20	Accessible changing cubicle within a main changing room	43
Figure 21	Key vertical dimensions to accessible shower area	44
Figure 22	Typical shower area for general use incorporating changing bench	45
Figure 23	Accessible shower cubicle incorporated into main shower cubicle area	45
Figure 24	Standard unisex accessible WC (left hand transfer)	47
Figure 25	‘Sports Chair Zone’ unisex accessible WC with power operated door set	47
Figure 26	Key vertical dimensions and fittings to accessible WC and changing area	47
Figure 27	General toilet provision incorporating wheelchair accessible toilet facilities	48
Figure 28	Signs and controls	51
Figure 29	Section indicating raised platform to bleacher seating for elevated wheelchair viewing	59
Figure 30	Typical sections through side or end ditch	77

1.0 Introduction

This guidance note sets out Sport England's advice on meeting the needs of the widest range of people in the design, operation and maintenance of sports facilities, following the principles of Inclusive Design. This includes considering the needs of parents with young children, older people, alongside the needs of disabled people – people with sensory, cognitive and mobility impairments, including wheelchair users.

This guidance note should be read alongside the other good practice documents referenced throughout this note and other relevant guidance available from the Sport England website

Other key reference should include the following:

- Olympic Delivery Authority's Inclusive Design Standards
- BS8300 : 2009 'Design of buildings and their approaches to meet the needs of disabled people – Code of Practice'
- FLA Accessible Stadia, 2004
- DfT Inclusive Mobility: a guide to best practice in the design of pedestrian and transport infrastructure.

Disabled people are disabled by poorly designed environments and providing add-on or special facilities creates segregation rather than inclusion. For example, the reason a wheelchair user cannot use the fitness equipment room in a sports centre is not because he or she is in a wheelchair. The design and management of the facility creates the barriers and limitations that disable. Consequently, the correct view would be that 'a wheelchair user cannot use the fitness equipment room because the equipment is inappropriate and / or the room is located on an inaccessible floor'. Or 'the person cannot use the fitness equipment room because the staff have not had adequate training'.



Disabled People

In the 2001 census 20% of the population claimed to have some form of disability. Disabled people have a wide spectrum of different and sometimes conflicting needs. Inclusive Design sets out to strike the best balance between all user needs and other demands on an environment, including cost.

- There are approximately 2,000,000 people in the UK with significant sight loss: of these, 364,615 are registered as blind or partially sighted¹. A logical layout, the use of colour, light levels and the avoidance of glare and clear signage are some of the design issues which are important to people with visual impairments.
- There are 8,945,000 deaf and hard of hearing people in the UK and there are 23,000 deafblind people in the UK. There are an estimated 50,000 people who use British Sign Language as their first or preferred language. There are 1,400,000 people who use a hearing aid regularly². The design of spaces to achieve good speech intelligibility, light levels and the avoidance of glare to assist lip reading, clear signage, as well as the installation of assistive hearing systems, such as induction loops are some of the design issues which are important to people with hearing impairments.
- There are 1,500,000 people with a learning disability in the UK. People with a learning

¹ Royal National Institute for the Blind

² Royal National Institute for the Deaf

Sport	Visual impairment				Learning disability				Mobility impairment				Wheelchair users			
	Recreational	National (GB)	International	Paralympics	Recreational	National (GB)	International	Paralympics	Recreational	National (GB)	International	Paralympics	Recreational	National (GB)	International	Paralympics
Angling	●	●	●		●	●	●		●	●	●		●	●	●	
Archery	●	●	●		●	●	●		●	●	●	●	●	●	●	●
Athletics	●	●	●	●	●	●	●		●	●	●	●	●	●	●	●
Badminton	●				●	●	●		●				●			
Basketball					●	●			●	●			●	●	●	●
Billiards/cue sports					●	●	●		●	●			●	●		
Boccia	●	●			●	●			●	●	●	●	●	●	●	●
Bowls	●	●			●	●	●		●	●	●		●	●	●	
Boxing	●				●				●				●			
Canoeing	●	●	●		●	●	●		●	●	●		●	●	●	
Cricket	●	●	●		●	●			●	●	●		●	●	●	
Cycling	●	●	●	●					●	●	●	●				
Dragon boat racing	●	●	●		●	●	●		●	●	●		●	●	●	
Equestrian	●	●	●	●	●	●	●		●	●	●	●	●	●	●	●
Fencing									●	●	●	●	●	●	●	●
Goalball	●	●	●	●												
Gymnastics	●	●	●		●	●	●		●	●	●		●	●	●	
Hockey	●	●			●	●			●	●			●	●	●	
Judo	●	●	●	●												
Netball					●	●							●	●		
Orienteering	●	●	●		●	●	●		●	●	●		●	●	●	
Rowing	●	●	●		●	●	●		●	●	●	●	●	●	●	●
Rugby union					●	●			●	●						
Sailing	●	●	●	●	●	●			●	●	●	●	●	●	●	●
Shooting	●	●	●	●									●	●	●	●
Skiing	●	●	●	●					●	●	●	●	●	●	●	●
Soccer	●	●	●	●	●	●	●		●	●	●	●	●	●		
Sub-Aqua	●				●				●				●			
Swimming	●	●	●	●	●	●	●		●	●	●	●	●	●	●	●
Table tennis					●	●	●		●	●	●	●	●	●	●	●
Tennis	●				●				●				●	●	●	●
Trampolining	●				●				●				●			
Triathlon	●	●	●		●	●	●									
Volleyball					●	●	●		●	●	●	●	●	●	●	●
Water skiing	●	●	●						●	●	●		●	●	●	
Weightlifting/powerlifting	●				●	●	●		●	●	●	●	●	●	●	●
Wheelchair rugby													●	●	●	●

Note: Deaf or hard of hearing people take part in all sports at all levels of participation, so have not been specifically referred to in the table.

Table 1 Disabled people participate and compete in a wide range of sports.

disability find it harder than others to learn, understand and communicate. People with profound and multiple learning disabilities need full-time help with every aspect of their lives - including eating, drinking, washing, dressing and toileting³.

- There are 4,900,000⁴ people with mobility impairments and approximately 1.45% of the population, as a whole, are regular wheelchair users. Changes in level, gradients, surface finishes and travel distances are particularly important considerations when including people with mobility impairments.

It is important to remember that it is common for disabled people to have multiple impairments.

We live in an ageing society and there is a strong correlation between age and disability. Therefore, it is important that we design, manage and operate facilities in a manner which meets user expectations in the 21st century and allows the widest group of people to play an active part in sport as participants, spectators and members of staff.

By considering people's diversity, inclusive design seeks to provide an environment which addresses a wide spectrum of needs. In this way it can break down barriers and remove exclusion.

"The quality of buildings and spaces has a strong influence on the quality of people's lives. Decisions about the design and management of places can enhance or restrict a sense of belonging. They can

increase or reduce feelings of security, stretch or limit boundaries, promote or reduce mobility and improve or damage health"⁵. The aim of this guidance is to integrate a wide range of user needs into new and existing sports facilities.



The Legislative Context

Disability Discrimination Duties

The Disability Discrimination Act 1995 places a duty on employers and service providers to prevent discrimination against people on the grounds of their disability. This includes a requirement to make reasonable adjustments to policies, practices and procedures and to remove physical barriers to accessing services.

The Disability Discrimination Act (DDA) 2005 amends the DDA 1995 and places an additional duty on all public authorities, including local councils, to actively promote disability equality and take account of disabled people's needs, even where that involves treating disabled people more favourably than non-disabled people.

This latter requirement goes further than avoiding discrimination in the way a public authority delivers its services and functions. Public authorities are required to carry out an equality impact assessment of all policies and practices and to produce a Disability Equality Schemes (DES) and Action Plan describing how it will promote disability equality.

Adopting the principles of inclusive design should be seen as an important part of meeting these DDA duties. For more detailed information on the DDA please visit the Equality and Human Rights Commission website.

www.equalityhumanrights.com

³ MENCAP

⁴ UK National Statistics

⁵ CABE (2008) Inclusion by Design: equality, diversity and the built environment.

Building Regulations 2000 Part M

Part M of the Building Regulations sets minimum functional access standards for buildings, but it must be recognised that Part M does not cover all of the inclusive design issues which are important in the design of sports facilities or to a high enough standard to create truly inclusive environments. Therefore, Sport England expects designers to refer to Sport England guidance, as well as the 'Approved Document M' (currently 2004 edition) which supports Part M, when designing sports facilities.



2.0 The Inclusive Design Process

Inclusive design should be seen as a continuous process - from the initial concept, the design brief or master plan, through to the detailed design; the planning and building control approval processes; onto construction and the operation, management and maintenance of the completed facility. Each of these stages should be an inclusive process in themselves, involving potential users, including disabled people.

Involvement

The involvement of disabled people is a key element of Inclusive Design and is a requirement of the DDA 2005 for public authorities. Local sports user groups and Access Groups can be useful points of contact in this respect. The latter are a useful source to consult on a design, as they are able to give advice based on personal experience and local knowledge. Access Groups work in different ways and have different levels of experience and technical expertise. In most cases the membership of volunteers includes people with mobility impairments. Many of these Groups include people with hearing or visual impairments. However, only a small minority have members with learning difficulties or who use mental health services.

Inclusive Design Champion

Regardless of the scale of a redevelopment or new build project, someone involved with the design of a project must champion the principles of inclusive design. This should be undertaken from the early briefing stages for a scheme and provide on-going good practice advice and reviewing of the proposal at key stages to ensure that aims are being met. The Inclusive Design Champion must have a detailed technical knowledge and understanding



of the diverse and sometimes conflicting needs of disabled people within sports environments. This includes the needs of everyone, from people with sensory and cognitive impairments to people with mobility impairments, including wheelchair users. To give balanced recommendations the Champion must also have an appreciation of other users needs including children and older people. An understanding of design and construction is also important in order to understand the other demands on the design or redevelopment of a sports facility⁶.

How will people use the facility?

When designing a sports facility it is necessary to visualise how people will use the facility as a whole, from transport links, to the initial approach, through to specific areas, for example the changing rooms, the social area and activity spaces. It is also essential to identify the potential obstacles and restrictions that a disabled person may face. Depending on the type of facility, some key areas of consideration might be:

- Before a visit finding out what facilities are available via websites, brochures, telephone
- Booking in advance and knowing what access arrangements to expect
- Parking
- Arriving by taxi, bus or coach at a drop off point
- Finding and reaching the entrance
- Buying a ticket
- Passing through the entrance doors
- Finding and using the changing rooms
- Accessing and using the fitness room, court, pool, athletics track and other sporting areas
- Wayfinding
- Finding and using the toilet facilities.
- Finding and using the social facilities.
- Finding a convenient seat/location from which to view a game with friends.
- Most importantly, how will they evacuate quickly and safely in an emergency

⁶ Registered Access Consultants may be suitable for this role, see the National Register of Access Consultants website at www.nrac.org.uk

Accommodating sports chairs

Over recent years the design of sports chairs has developed and in some cases sports chairs now require a design width of 1.2m making it impractical to achieve this throughout the facility. It is therefore essential to establish those areas where sports chair access is required to ensure proper access.

In facilities such as sports centres and tennis centres, where sports chairs are a key piece of sports equipment for some people and some sports, it is essential that the design of the building and the external works ensures that the sports chairs have unhindered access to all sports activities / facilities.

To achieve this a 'sports chair zone' must be established. This a zone where the circulation and the elements within it, such as doors and lobbies, are designed to allow large sports chairs to be used, manoeuvred and stored easily and safely. The minimum extent of the wheelchair zone in any sports chair facility consists of:

- The route from the site entrance, car park, setting down point to the entrance and reception area.
- The route from the entrance/reception to a safe, convenient and secure storage point for the sports chair.
- The route from the storage point to the activity area e.g. sports hall or outdoor/indoor tennis court
- The means of escape route from the activity area to a place of safety.

This will allow a user to arrive at the facility and enable them to push their sports chair in front of them, in most cases from their 'day chair', to and through the entrance and into the reception area.

From reception they will continue to push their sports chair to the secure storage point which must be conveniently located close to the changing areas. Having secured their sports chair they will then move to the changing and toilet facilities prior to returning to the secure area where they will transfer into their sports chair and then secure their day chair. Once in their sports chair the user will then travel to the sports activity space. After their sports activity the user will return to the secure storage to transfer into their day chair and will then either secure their sports chair and move into the other parts of the sports facility or return to reception and exit the facility.

In summary, when considering how disabled people will use any part of the facility it is important to ask the following questions:

- How will they find it?
- How will they reach it?
- How will they use it?
- How will they leave the facility?



Adapting and Improving Existing Buildings

Many sports facilities were designed and constructed in a way that makes the facilities difficult or impossible to use for many disabled people. In some of these, enlightened management practices have overcome many of the barriers to access despite the physical constraints of the building.

When altering or extending a sports facility, it is essential that the project be developed with the clear aim of achieving full accessibility. The first step in achieving this is to carry out an access audit. This will establish the current situation and inform the design and development of the project. It will help create the basis for a programme of works and a written access policy.

Extensions

All new extensions to sports facilities must meet the requirements of this guidance note and the design of the extension must improve access to the existing facility.

Alterations

Where substantial work is planned to an existing facility the project must aim to comply with the full requirements of this guidance. When making alterations or simply carrying out maintenance, the access implications and the potential for incorporating improvements within the proposed work should be carefully considered. The following points should be borne in mind:

- The proposed work must not make the access situation worse.



- Where it is not reasonably practicable to achieve current standards of accessibility, a costed and prioritised action plan should be prepared with the aim of achieving the requirements in the medium to long term. The action plan should also identify how the current arrangements can be managed in the short term. This may require changes in policies, practices and procedures to achieve the best level of accessibility in the circumstances; a written policy should be produced describing the potential barriers and identifying the arrangements to minimise the impact on disabled people.
- Most access improvements do not involve expensive complex changes to the physical environment or major changes to how it is managed.

Access Audits

The Inclusive Design Champion should carry out an Access Audit of an existing sports facility prior to developing maintenance programmes, redevelopment schemes or extensions, to inform the brief for the project. The Audit should highlight inclusive design issues which should be addressed within the proposals. The project must aim to make the existing facility meet current good practice, including meeting the standards in this guidance note.

Access Statements

An Access Statement should be prepared to explain how any new build or redevelopment proposals will address the principles of inclusive design.

An Access Statement should evolve throughout the briefing, design and construction process, beginning as a strategic document where aspirational, but achievable, aims are set for a project, developing into a detailed final document which is handed over to the owner of the sports facility on completion. The Statement should act as an agenda for an ongoing dialogue between all stakeholders at each stage of the project. It can help to ensure that inclusive design issues and their management implications are given due consideration alongside other demands made on a development, providing an audit trail of issues, assessments and actions. The exact form of a Statement will depend on the size, nature and complexity of the development.



Sport Scotland has produced detailed guidance on writing Access Statements, Facilities Report 03: Inclusive Design and Access Statements, 2008.

www.sportscotland.org.uk/ChannelNavigation/Resources/TopicNavigation/Publications/Facilities+Report+03.htm

3.0 Arriving At The Facility

Disabled people arrive at sports facilities by a variety of means, most commonly by car, minibus or taxi. However, arrangements should be made for those arriving by wheelchair, bicycle or on foot and, where possible, for those arriving by public transport. It is essential that there is clear signage and good lighting at the entry from the public highway indicating routes to:

- Car parking areas, specifically accessible car parking spaces.
- Setting-down point.
- Principal entrance to the facility via a safe route.

Car parking

Detailed guidance on the design of car parking areas is available in the 'Approved Document M' of the Building Regulations, in BS8300 and in Sport England's 'Car Park and Landscape Design' design guidance note available on the website. However the key issues are summarised here.

A car is essential for many disabled people to access sport and leisure facilities, so it is vital to provide suitable parking with unhindered access to the entrance:

- Provide at least the minimum number of specifically reserved, accessible car parking spaces for people with disabilities appropriate to the scale of the facility as indicated in Table 2.
- Group bays together and signpost their location from the main entrance to the site. See Figure 2 of BS8300.
- Bays must be clearly laid out and signed, both on the surface of the bay and by means of a vertical sign. See Figure 3 of BS8300.



Clear Signage at the entry from the public highway is essential

- Establish a management/supervision system to ensure that the designated parking bays are used only by people entitled to do so.
- Bays must be located as close as possible to the main entrance of the building. If the pathway to the entrance is uncovered the distance to the entrance must be no more than 50m; this can be increased to a maximum of 100m if the pathway is covered.
- The car park surface should be smooth and even. Unbound surfaces such as gravel are not acceptable.
- Kerbs must have dropped sections at all points where wheelchair users may want to cross. See BS8300.
- The height of ticket, swipe-card or key-activated car park barriers should conform to the requirements of BS 6571-4. See Figure 5 of BS8300.
- Vehicle height barriers should have vertical clearance of 2.6m to allow the passage of high conversion vehicles.
- Audible barrier controls must have alternative provision for people with hearing and speech impairment.

Provision	Clubhouses/pavilions (serving only natural turf pitches)	Clubhouses/pavilions generally	Full-size synthetic pitch	Multi-use games area	Fitness suite	Four-court sports hall	Six-court sports hall	Nine-court sports hall or larger	Cricket indoor	Gymnastics hall	Tennis indoor	Tennis outdoor	Bowls indoor	Bowls outdoor	Table tennis centre	Athletics indoor	Athletics outdoor	20m swimming pool	25m swimming pool	50m swimming pool
Minimum of 2 accessible car parking bays or 6%, whichever is the greater	2	2	2	2	2	4			4	2	4	4	2	4	4	4	4	4	8	
Minimum number of accessible car parking bays or 8% whichever is the greater						○	6	8	○		○	○	○		○	○	○	○	○	8
Setting-down point adjacent to the entrance	●	●	●	●	●	●	●	●	●	●	●	●	●	●	●	●	●	●	●	●

Key: ● Required ○ Recommended

Table 2 Accessible car parking spaces – requirements

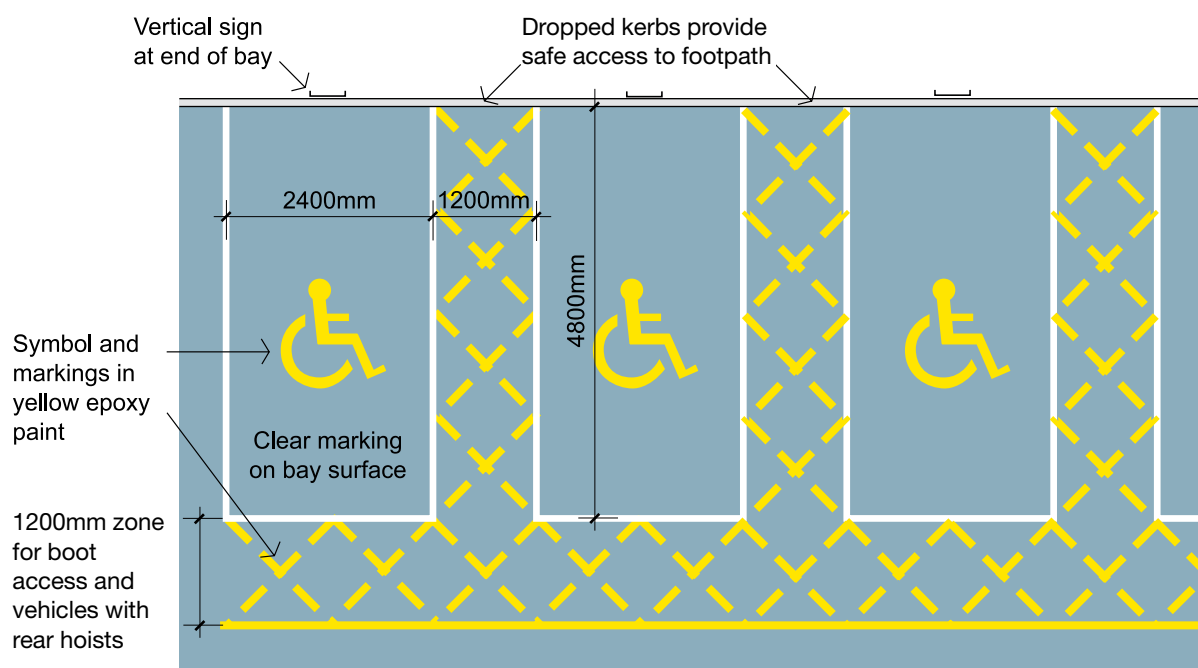

Figure 1 Accessible car parking bays

Setting-down point

A setting-down point must be provided. Ideally, this should be sheltered and immediately adjacent to the main entrance. Note the following points:

- The bay should be long enough to allow 'tail-loading'.
- For smaller facilities where a drop-off point at the main entrance may be impractical, the distance between the nearest drop-off point and the sports facility should be no more than 50m if the pathway is uncovered.

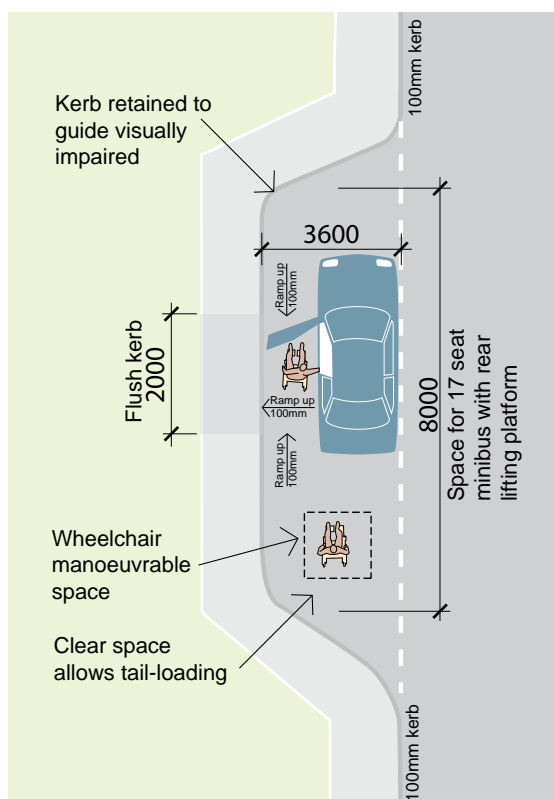

Figure 2 Setting-down point

Cycle Parking

Provision should be made for parking cycles in secure locations away from pedestrian routes.

Consideration should be given to providing weather protection to cycle parking.

Space should be available for adapted cycles and tandems.

Designers should refer to the DTI publication 'Inclusive Mobility' to ensure that the design and location of cycle parking is safe and appropriate. Many cycle racks are lower than 1.0m, the minimum height street furniture should be. In addition many cycle racks have no lower rail which

makes this furniture difficult to detect for blind and partially sighted people.

To enable everyone, particularly people with disabilities, to move conveniently and safely from their arrival point to the entrance, careful attention is needed to the layout and detail of paths, ramps, steps and handrails. All routes should give sufficient audible and tactile information, supplemented by visual clues, to help blind and partially sighted people

Routes to the facility

Detailed guidance on the access routes to and around buildings is available in Section 5 of BS 8300.

- Provide landmarks along routes to help orientation.
- Traffic routes should be clearly distinguishable from pedestrian routes through use of texture and colour.



A dedicated footpath with olfactory and tactile information will assist visually impaired people

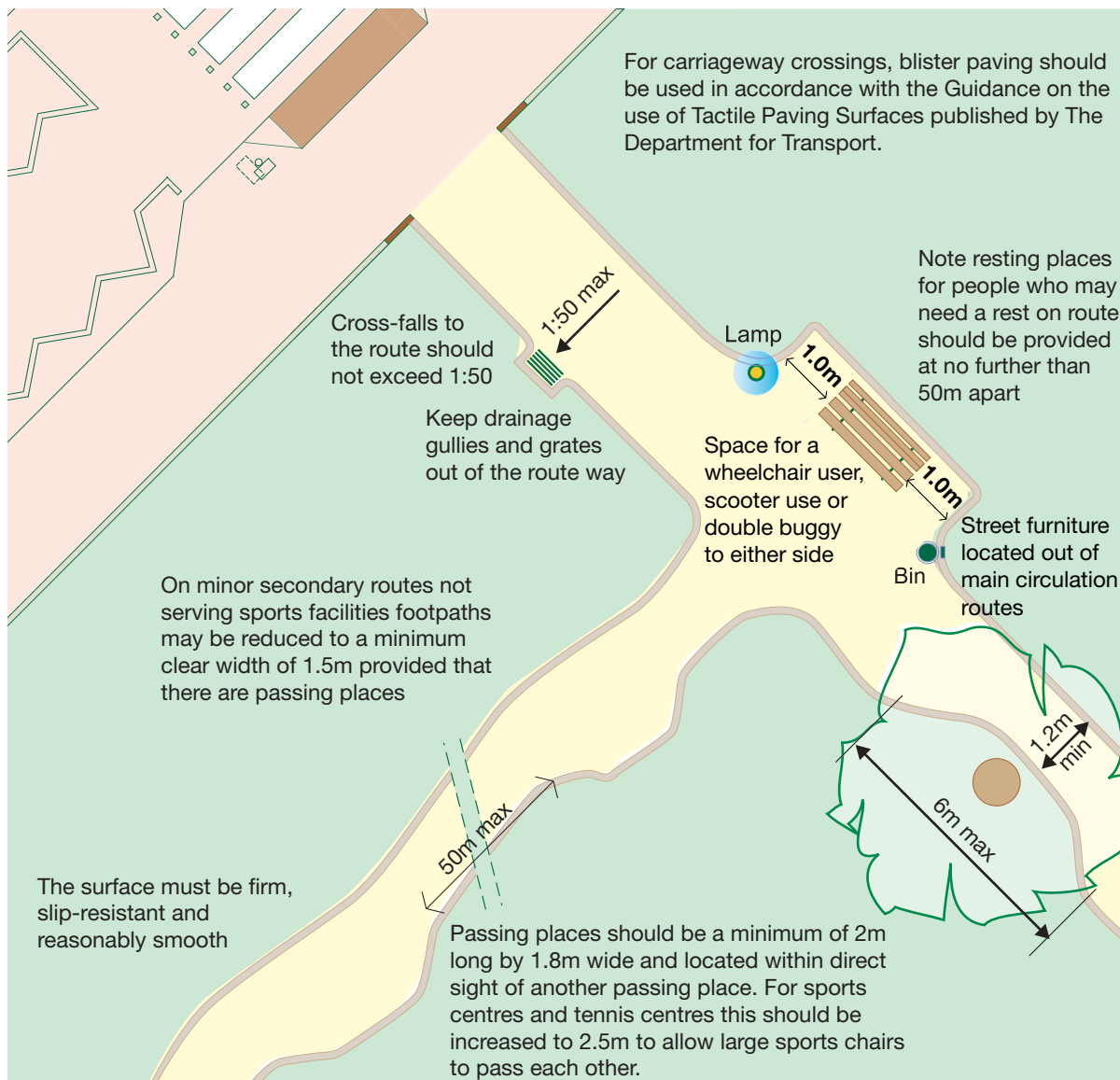

Figure 3 Designing an Access Route

- To be accessible, routes must be a minimum of 1.8m clear width where they serve sports facilities. This should be increased in large facilities.
- In sports centres and tennis centres the design of the route from the drop off point, car park and site entrance to the sports facility, indoor and outdoor facilities, must be designed and detailed to allow easy access for someone using a wheelchair who is also pushing their sports chair in front of them.
- Street furniture such as lamps, bins and so on must be out of the route way.
- At unavoidable pinch points no greater than 6.0m in length the path can be reduced to 1.2m min clear width.
- Splay corners at junctions to ease manoeuvring for wheelchair users.
- Ensure minimum clear height of 2.1m is maintained under trees, canopies, brackets and so on.
- Access routes should be level (ie less than 1:60) or have the shallowest gradient possible. Where the route is steeper than 1 in 60 but not as steep as 1 in 20, it must have a level landing for each 0.5m rise along the route. Wherever there is a change of direction in a ramp, a level landing must be provided. Where the gradient is 1:20 or steeper it must comply with the requirements for a ramp.
- Wherever the change in level along a route is greater than a single step then an alternative stepped approach should be provided as some people find it significantly easier to negotiate a short flight of steps than a ramp.

- Materials should be used thoughtfully. They can provide different sound and tactile qualities and, with proper use of colour, will aid location along the route. If used indiscriminately, however, they can be confusing and even dangerous.
- Where footpaths cross vehicle routes provide warning and guidance for blind and visually impaired people. Ensure there are no obstacles or hazards, for example gratings, to obstruct crossing points.
- Crossings should be at least 1.2m wide minimum.
- Careful design of planting schemes will aid location by providing scent and colour clues and in some instances can provide key landmarks for the visually impaired user. Ensure plants do not overhang route ways.
- On access routes on level ground provide seated resting places not more than 50m apart for people with impaired mobility. For routes where the gradient is between 1:21 and 1:60 additional resting places should be considered.

External Features

Layout

- Footpaths should be at least 1.8m wide minimum. At unavoidable pinch points around obstacles such as trees, an absolute minimum width of 1.2m is acceptable providing this does not exceed 6.0m in length.
- Provide splayed or rounded angles at junctions with other footpaths.
- Designers should refer to the DTI publication 'Inclusive Mobility' to ensure that the design and gradient of footpaths is safe and appropriate.
- Drainage cross-falls of footpaths should not exceed 1 in 50 as steep cross falls make it difficult to control a wheelchair.

Detailed guidance on the design of access routes to and around buildings can be found in Section 5 of BS8300 and Approved Document M.

Materials

All surfaces should be slip-resistant in all weather conditions.



- Unbound surfaces should be avoided on principal routes to and between facilities, for example gravel hogging.
- All surfaces should meet with a level and even junction.
- All gratings should be flush with paving and located beyond the boundaries of the access route.
- Block paving should be laid evenly.
- Dished drainage channels are trip hazards and should be avoided on access routes.
- Footpaths should be well illuminated to avoid the creation of contrasting pools of light and darkness (100 lux to steps and ramps, 50 lux on main routes).

Signs

Guidance for the design of signs can be found in Section 10 and The Sign Design Guide (see contact addresses).

Signs should be part of a carefully considered, comprehensive signage system to ensure that they are:

- Carefully located
- Clear, simple and logical
- Non-reflective.

Ramps

It is essential for ramps rising 0.3m or more to be accompanied by a short flight of steps for use by those who find negotiating a ramp more difficult than using steps.

Where it is not possible to use a level approach, a ramp will enable safe and convenient access for people with pushchairs or wheelchairs and for deliveries.

Issues to consider include:

- A gradient of 1 in 21 is considered level; any gradient steeper than this is classified as a ramp.
- The gradient should be as level as possible, between 1 in 20 for a maximum length of 10.0m and 1 in 15 for a maximum length of 5.0m.
- The absolute maximum gradient is 1 in 12 over a maximum length of 2m. This should be used only where no alternative is available.
- The surface colour of ramps should contrast visually with that of landings to enable visually impaired users to anticipate them.
- All ramps should have slip-resistant surfaces that are firmly fixed and easily maintained.
- Ramps should be illuminated to at least 100 lux.
- All ramps should be provided with handrails on both sides. Minimum clear width 1.3m except where sports chairs may be used – for example at tennis clubs or sports centres, in which case they should be at least 2.0m clear width. For long ramps, a wider ramp or the provision of passing points may be beneficial.
- If the ramp is exposed to the extent that people might feel vulnerable consider providing a solid balustrade.
- A minimum clear landing of 1.5m should be provided at the top and bottom of each ramp. All landings should be clear of door swings.

Detailed guidance and standards for ramps can be found in BS8300 and related sections of Approved Document M.

Steps

Some people, in particular ambulant disabled people, prefer 'easy going' steps and these should always be located adjacent to ramps.

- Do not use open risers; all risers should be solid.
- A minimum clear landing of 1.2m (1.8m preferred) should be provided at the top and bottom of each flight of steps. All landings should be clear of door swings.
- Straight flights are easier to negotiate than curved or dogleg flights. However, a series of straight flights can be intimidating to people with a fear of heights.
- Step treads and risers should be consistent and in the range of 0.15-0.17m for risers and 0.25-0.3m for treads.
- Avoid single, isolated steps.
- Twelve is the maximum number of risers in any flight.
- Each step nosing should contrast in colour and luminance with the adjacent tread.

Detailed guidance and standards for stepped access can be found in BS8300 and related sections of Approved Document M.

Handrails

Handrails are to be provided on both sides of all steps maintaining at least 1.0m clear width.

It is important that the handrail is available before a person starts climbing or descending a flight of steps. In order to facilitate this, the handrails must project horizontally beyond the top and bottom steps by at least 0.3m.

The colour or brightness of the handrail should distinguish it from its background.

Detailed guidance and standards for the provision and design of handrails can be found in Section 5.10 of BS8300 and related sections of Approved Document M.

Street Furniture

It is essential to locate street furniture carefully as it can create serious problems for people with sight impairment as well as causing obstacles for people with pushchairs and wheelchairs. Used correctly, street furniture can create interest and give visual clues to aid location.

Detailed guidance on the location of street furniture can be found in Section 5.7 of BS8300 and in Section 3.7 of Inclusive Mobility 2009.

The Approach

The entrance to the building should be an obvious feature on the facade. The message should be reinforced by the use of colour, lighting and signage. However, avoid large areas of uniform colour and texture in the hard landscaping. Use the opportunity to relate the building to its surroundings and avoid unattractive and desolate approaches as these can prevent people with visual impairment from locating the entrance and/or main routes.

The approach to the entrance should be designed so that hard and soft landscaping reinforces the route to and the location of the entrance.

Note the following requirements:

- The route to the entrance should be segregated from vehicles
- The route to the entrance from parking and drop off should be as short as possible, since many disabled people can only travel 50m with relative ease.
- Provide obvious and clear signage in the correct location.
- Avoid windows, doors and other objects projecting into pathways. All outward opening doors should be recessed or safeguarded by railings.
- Elements such as street furniture, columns and roof brackets should be carefully located and detailed so that they are not a hazard. Particular care should be taken adjacent to the building entrance.

- Provide appropriate seating adjacent to the entrance. Where there are pedestrian routes greater than 50m in length, provide seats/resting places. There should be space to enable wheelchair users to rest beside seats. Seats and wheelchair spaces should be set back from the pathway.

Assistance Dog Toilet Areas

An assistance dog is likely to need access to a designated toilet area away from other activities.

Note the following requirements:

- The area should have a concrete surface easy to clean and have provision for regular sanitation cleaning.
- All facilities should have an assistance dog policy (see management section).
- It should be free from litter, glass and other harmful articles.
- Appropriate internal provision should also be considered.



Sports facilities must be designed and managed to be accessible to people with assistance dogs

4.0 The Entrance

The building should be designed to make the entrance obvious and the facility inviting to everyone. Ensure the following:

- The entrance should be easily distinguishable from the facade as a whole.
- The entrance must have a level area immediately in front of the entrance door to make the entrance more accessible to wheelchair users.
- The entrance should be accessible to everyone. There should not be a separate / segregated entrance for different groups of people.
- Entrance doors must be sited logically in relation to approach routes.

See BS8300 Section 6.

External doors

All large facilities, and those where a significant amount of wheelchair sport takes place, need to be fitted with automatically controlled doors. Avoid revolving doors.

Entrance doors should not be made of highly polished material such as stainless steel. They should, however:

- Be a suitable width for the scale and type of facility (see Table 3).
- Be fitted with level thresholds (maximum vertical projection 15mm).



- Be free of hazardous gratings adjacent to the door and its approach.
- Be distinguishable from adjacent walls and screens.
- Have vision panels.
- In smaller facilities where automatic doors are not provided, a doorbell or intercom should be provided to attract the attention of the staff for assistance.

Minimum clear width	Clubhouses/pavilions generally, except those serving tennis, athletics or outdoor basketball	Full-size synthetic pitch	Multi-use games area	Fitness equipment room	Four-court sports hall	Six-court sports hall	Nine-court sports hall or larger	Cricket indoor	Gymnastics hall	Tennis indoor	Tennis outdoor	Basketball outdoor	Bowls indoor	Bowls outdoor	Table tennis centre	Athletics indoor	Athletics outdoor	20m swimming pool	25m swimming pool	50m swimming pool
1000mm	●	●	●	●					●			●	●	●	●	●	●	●	●	●
1200mm					●	●	●	●		●	●									
Automatic doors				○	●	●	●	●	○	●			●		○	○		●	●	●

Key: ● Required ○ Recommended

Table 3 External doors – requirements

Glazed doors and associated side panels should not incorporate fully glazed frameless entrance doors. They should:

- Be distinguishable from their surroundings, with features such as signs and logos located at eye level, that is 1.4–1.6m above ground level.
- Repeat safety markings at low level that is 0.85–1.0m if the glazing goes to the floor.
- Ensure these distinguishing features, are visible from both sides of the door.
- Comply with BS 6262–4.

Automatically controlled doors should:

- Have a sliding, bi-fold or telescopic arrangement – hinged (swing) or folding doors can be used in exceptional situations.
- Be designed to minimise the risk of accident as an automatic swinging or folding door can be a serious hazard. In particular, the leading edge should be protected so that people cannot walk into it. Also the leading edge should be highlighted to contrast with the rest of the door so that it is more easily detected.
- Be capable of manual operation in the event of power failure.
- Comply with BS 7036: Parts 1 & 2.

- Be operated by a sensor that prevents the door closing on users and is sensitive to people who are seated or children, as well as sensing someone who is standing.

In situations where an automatic ie sensor controlled, door control is not required but a power-operated door is to be provided. The ‘push-pad’ should be located at a height between 0.75–1.0m, be clearly visible and be of a contrasting colour and luminance to its background.

Entrance lobby

- The layout and dimensions of the entrance needs to be appropriate to the facility’s size and type. Where inner and outer (lobby) doors are provided the dimensions are critical for wheelchair users as they will need to be able to move clear of the first set of doors before encountering the second.
- The entrance lobby size and design should allow for a wheelchair user pushing either their sports chair or day chair in front of them as they enter the facility.
- A recessed cleaning surface/mat should be provided within the entrance lobby to prevent moisture being brought into the building on peoples shoes/wheelchair and buggy wheels. The mat must not create a trip hazard. Coire matting and similar materials must not be used.

Provision	Clubhouses/pavilions (serving only natural turf pitches)	Clubhouses/pavilions generally	Full-size synthetic pitch	Multi-use games area	Fitness suite	Four-court sports hall	Six-court sports hall	Nine-court sports hall or larger	Cricket indoor	Gymnastics hall	Tennis indoor	Tennis outdoor	Bowls indoor	Bowls outdoor	Table tennis centre	Athletics indoor	Athletics outdoor	20m swimming pool	25m swimming pool	50m swimming pool
Reception desk including 'induction loop'					●	●	●	●	●	○	●	○	●	○	○	●	○	●	●	●
Public telephone	○	○	○	○	●	●	●	●	○	○	○	○	●	○	○	○	○	○	●	●
Textphone					○	○	●	●	○	○	○		○		○	○	○	○	●	●
Seating / resting area	○	○	○	○	●	●	●	●	●	○	●	○	●	○	●	○	○	●	●	●
Assistance dog rest					●	●	●	●	●		●		●	●	●	●	●	●	●	●

Key: ● Required ○ Recommended

Table 4 Reception area – requirements

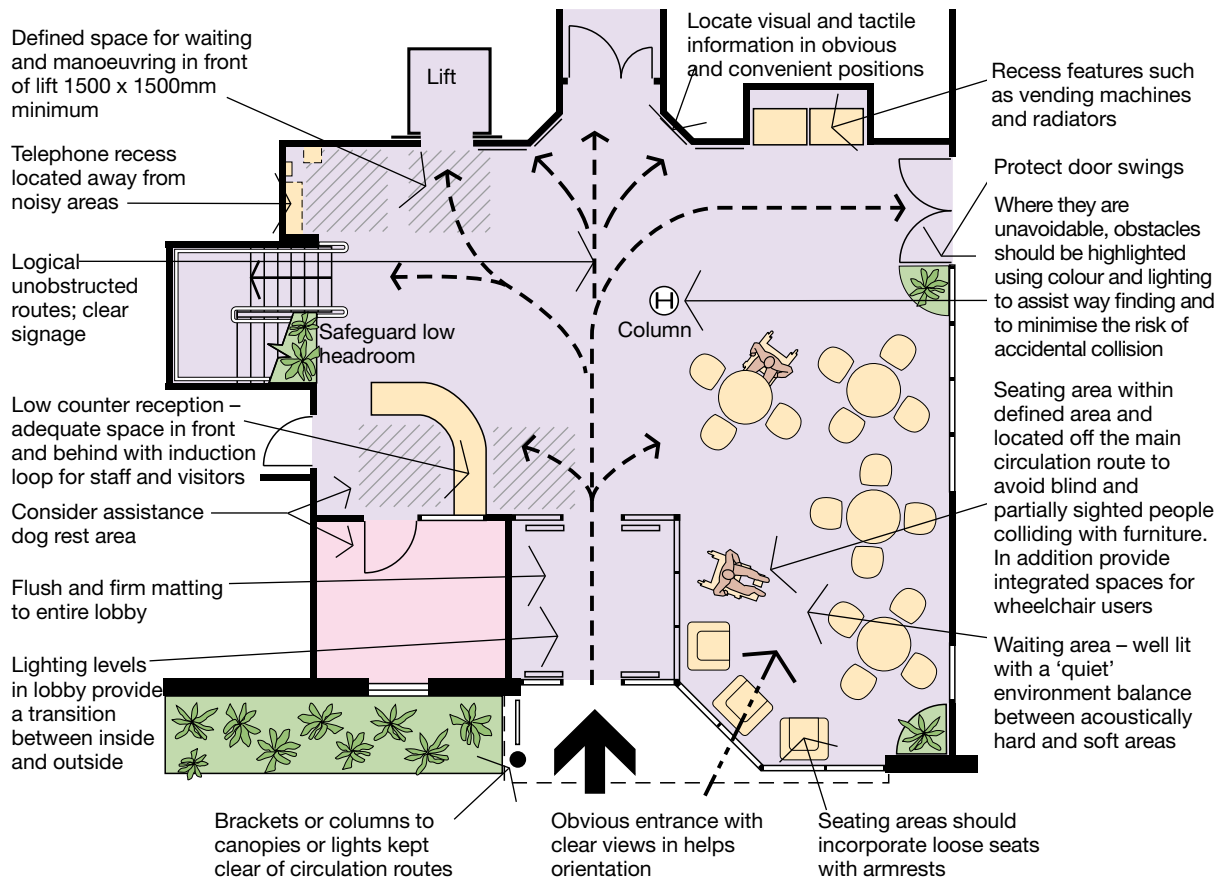

Figure 4 Reception Area

- Where space is necessarily limited, consideration should be given to omitting the inner doors, providing an effective overhead warm air curtain and adjusting the design of heating to the entrance area to minimise heat loss. The entrance should not face the prevailing winds in such circumstances in order to avoid unnecessary draughts.
- The level of lighting in the lobby should be adjustable to provide a smooth transition from external to internal lighting levels and vice versa.
- See BS8300 6.3.6 and Figure 8.
- People working in the reception area should have a clear view of the entrance.
- If turnstiles are provided ensure there is a pass gate to allow for people with pushchairs or wheelchairs. The gate should be electrically operated. If the turnstiles can be self operated via a membership card or similar, then any 'pass gate' should also be capable of being self operated.
- The lift, staircase and public telephone should be visible and close to the reception desk. Where a direct line of sight to these key facilities is not possible clear signage should indicate their whereabouts.

Foyer / Reception Area

The layout of the reception area should be clear and logical and minimise the need for signs to guide people through it. Close attention to detail is critical to the success of this space. See figure 4. The following should be considered:

- People coming through the entrance door should have a clear view of the reception desk. This includes considering the location of the desk and the use of colour and lighting to highlight its presence.
- Suitable seating is required for early arrivals and people who may be meeting friends before or after using the facilities.
- The acoustics within the reception area should promote clear speech intelligibility and particularly for interaction with staff at the reception desk which should be free from distractions. It is essential that hard reflecting surfaces, such as glass, be acoustically balanced with softer sound-absorbing surfaces, such as ceilings, carpets and curtains.

Reception desk

Where some form of reception/ booking desk is provided, it is essential that the desk or counter be properly designed to allow good access for all.

- The design of the counter should accommodate disabled members of staff behind the desk and disabled visitors in front of the desk. This includes considering the needs of wheelchair users, people of short stature and people who are deaf or hard of hearing.
- The desk should include a lowered section - see BS8300 Section 11.1
- The counter top and front should contrast visually in order to assist the location of the counter edge by blind and partially sighted people.
- Screens and grilles can inhibit communication and should only be used where essential for security considerations.
- An induction loop must be provided to assist users with hearing impairment and this must be clearly indicated using the standard symbol. Note: the induction loop should also be accessible from the lowered area of counter.

For some sports activities, for example swimming, it is not possible for the participants to take their assistance dogs with them. Where this may occur, a safe and secure rest space should be provided for the dogs; this could be within the reception area.

Public telephone

Except in the smallest facilities, such as small pavilions, a public telephone with an induction



The reception desk is designed for use from both sides by people using wheelchairs

coupler should be located in the reception area to allow people to call taxis, organise lifts, and so on.

Signs

Good, clear information is essential in all facilities:

- Only use signage to locate specific facilities and reinforce logical routes, confusing layouts should be avoided at the design stage.
- Large numbers of signs cannot necessarily overcome wayfinding problems created as a result of poor design of the facility. However, signage is essential in reinforcing wayfinding within well designed logical environments.
- The layout of the building and the use of appropriate floor and wall finishes and lighting can be used to convey navigational information.

Guidance for the design of signs can be found in Section 10.0 below and The Sign Design Guide.

www.signdesignsociety.co.uk

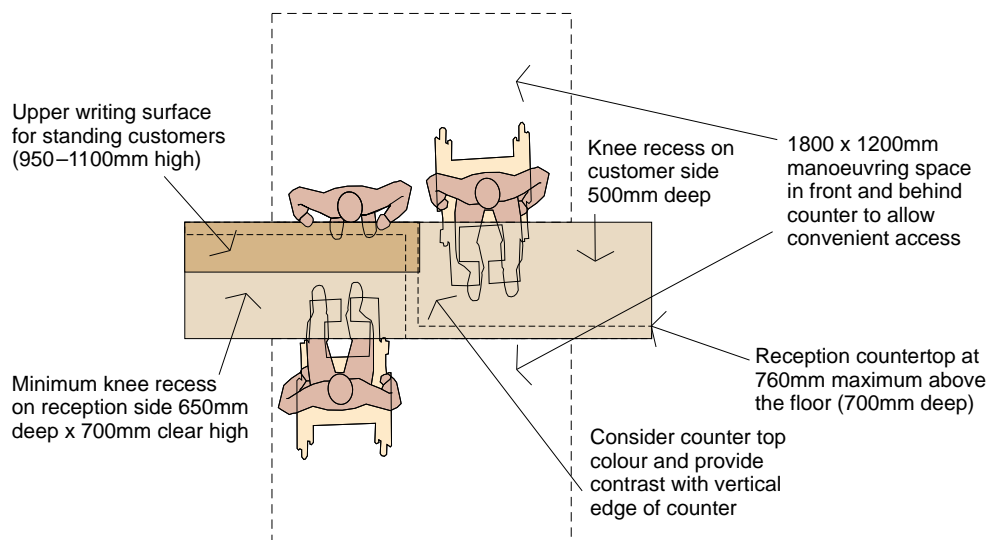

Figure 5 Reception Desk - key dimensions

5.0 Internal Circulation

Design the building to minimise the number of doors and the length of corridors that users have to negotiate. Consider carefully the location of internal columns and pillars; within the constraints of the design these should not be located in circulation areas where they may become obstructions. When this is not possible the obstruction needs to be 'highlighted' and protected by the use of appropriate details and decoration.

In facilities where sports chairs could potentially be used, the design of the internal circulation must take account of the requirements for a 'sports chair zone' - see page 9.

Corridors

See BS8300 and Approved Document M.

- As a minimum the unobstructed width of a corridor should be at least 1.5m. However, where the unobstructed width is less than 1.8m, it must have passing places at least 1.8m long and have an unobstructed width of at least 1.8m to allow wheelchair users to pass each other. If large numbers of wheelchair users are expected, the corridor width should be increased to at least 2.0m to allow wheelchair users to pass each other freely along main routes.
- In 'Sports Chair Zones' (see 'Accommodating sports chairs' on page 9), the unobstructed width of a corridor should preferably be 2.5m to allow users in large sports chairs to pass each other. However, the unobstructed width can be reduced to a minimum of 2.0m with the incorporation of passing places at least 2.5m long and with an unobstructed width of at least 2.5m - see fig 7. Passing places should be no more than 5m apart.
- Corridors should be wide enough to allow wheelchair users to approach and gain easy access through doors off the corridor.
- Corridors should be unobstructed; for instance, fire extinguishers, radiators, and so on should not project into the clear corridor width to ensure they do not present a hazard to children, wheelchair users or visually impaired people.
- Provide splayed or radius corners to walls at changes in direction or adjoining corridors wherever possible.
- Doors should be recessed when opening out into a corridor, to avoid a significant hazard.
- Avoid glazing at corridor ends.



Whenever possible doors should be held open to minimise the number of barriers on a route way. Splayed walls at corridor junctions will benefit blind or partially sighted people and wheelchair users

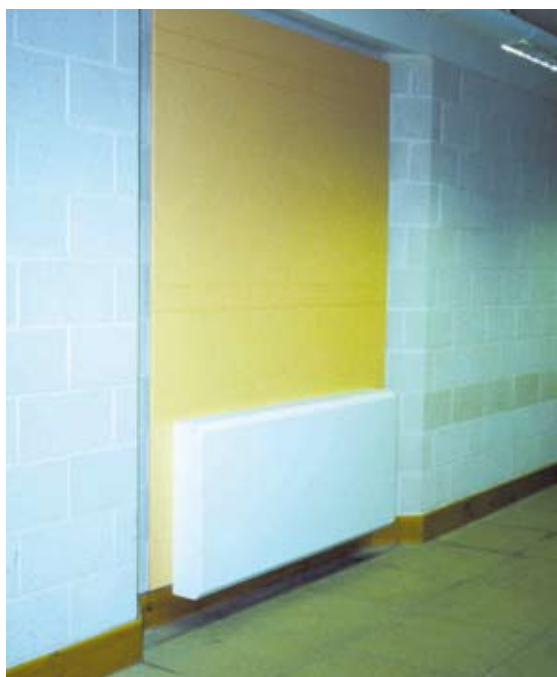

Radiators and other hazards should not project into circulation areas



Where doors must swing out into a corridor they should be set in a recess

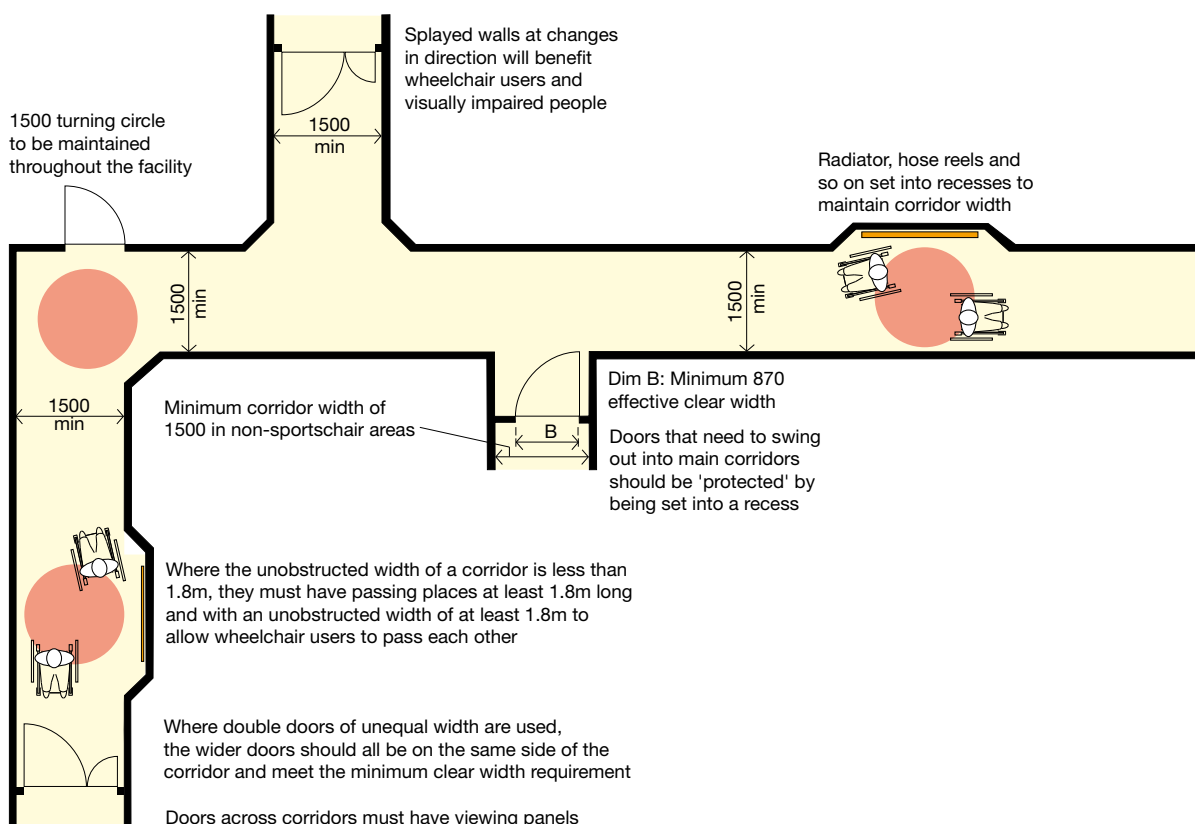

Note: All dimensions are in millimetres

Figure 6 Internal circulation for facilities WITHOUT 'Sports Chair Zones'.

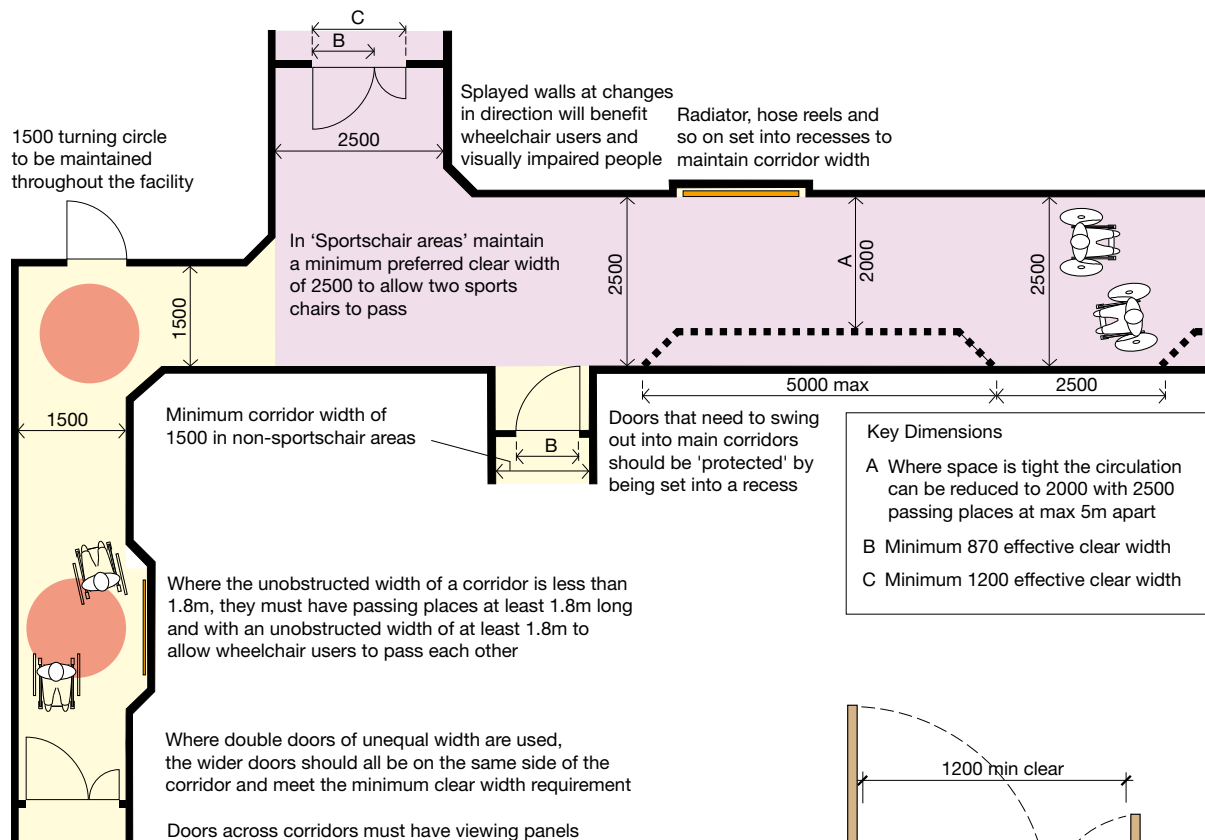

Note: All dimensions are in millimetres

Figure 7 Internal circulation for facilities WITH 'Sports Chair Zones'.

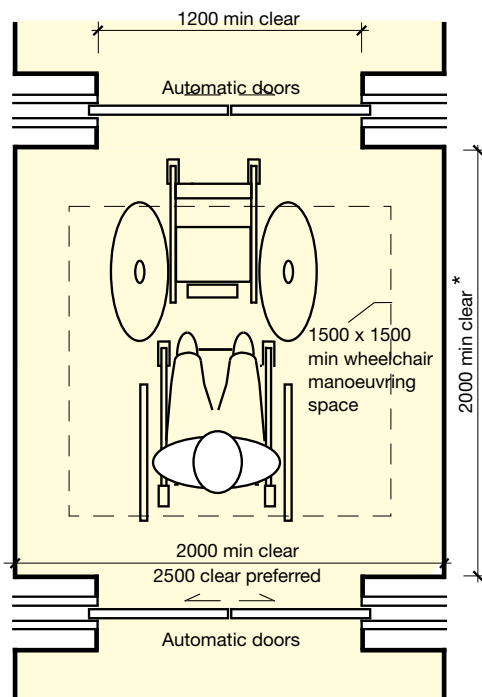

Note: lobbies for all other facilities in accordance with 'Approved Document M'

Figure 8 Entrance Lobby for sports halls and tennis centres with 'Sports Chair Zones'- minimum dimensions (mm)

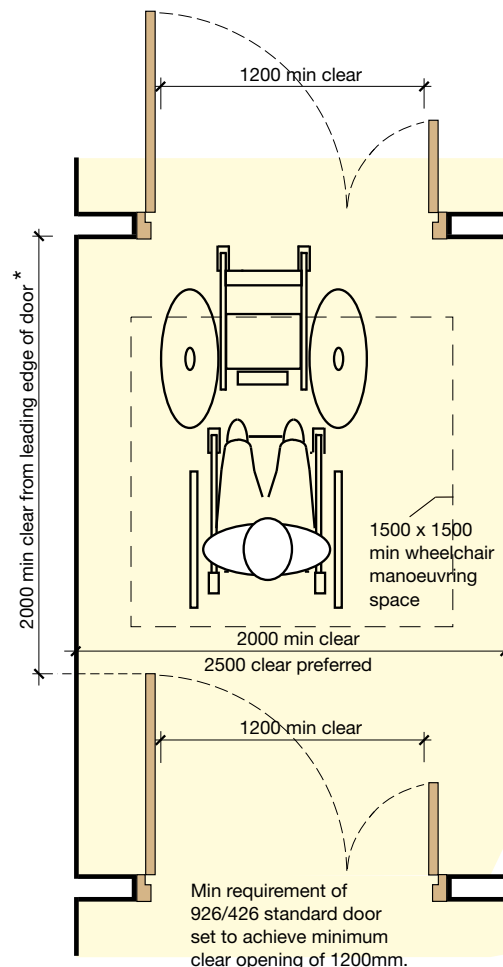

Note: lobbies for all other facilities in accordance with 'Approved Document M'

Figure 9 Internal Lobby for sports halls and tennis centres with 'Sports Chair Zones'- minimum dimensions (mm)

Lobbies

- Minimise the number of internal lobbies as they can impact upon efficient use of the facilities. Where unavoidable internal lobbies should be of the appropriate size and layout

Ramps

See BS8300 and Approved Document M.

Avoid small changes in level within a storey whenever possible. However, where this is not practicable, all ramps and steps must be carefully designed. Where the complex is on two levels the following provision should be made:

- All ramps should have a minimum clear effective width of 1.5m except in the 'Sportschair Zone' of buildings such as Sports Centres and Tennis Centres where the clear effective width should be increased to 2.5m so that 2 large sports chairs can pass each other.
- Ramp gradients should be as shallow as possible. Where the gradient is less than 1 in 20 level landings/rest points should be provided every 0.5m rise.
- The maximum rise of any series of ramps should be 2.0m.
- In exceptional circumstances, short ramps with a maximum length of 2.0m between landings may be incorporated with a gradient no steeper than 1 in 12.
- Intermediate landings between ramps should be at least 1.5m long.
- Ramps should be surfaced with firmly fixed, slip-resistant and easy to maintain materials.

Stairs

See BS8300 and Approved Document M for more detailed advice.

- There should be a clear width of 1.1m except in small facilities where a minimum of 1m is acceptable.
- The maximum rise of each flight is 1.8m with risers no greater than 0.17m and treads no less than 0.25m.
- All steps, no matter how few, should be fitted with a suitable handrail on both sides (see later section).
- All landings must be level and at least



Wherever possible, a ramped change in level should be accompanied by a short flight of steps suitable for ambulant disabled people who may find a ramped surface difficult to negotiate. The steeper and more extensive the ramp configuration, the more important it is to provide a short flight of steps.

1.2m long and clear of obstructions such as door swings. Intermediate landings should be a minimum of 1.2m wide and 1.5m long.

- All changes in level, including landings, are to be fitted with a continuous handrail.
- Tapered treads, spiral stairs and open risers present special hazards and should not be used.
- All stair nosings need to be clearly visible and made of contrasting slip-resistant material. The nosing should wrap around the riser so that it extends 55mm on the tread and 55mm down the riser.
- All staircases should be illuminated to at least 100 lux at tread level and be designed to ensure that people do not have to negotiate stairs in their own shadow.
- Avoid using glossy, polished materials that can cause glare or reflections that may impact on the safety of the stair.
- Ensure open areas under stairs are either free from head injury hazards likely to cause injury or are suitably guarded.

Handrails

See BS8300 and Approved Document M.

Handrails must be provided at all changes in level, however small, and give adequate grip and support. They should also take account of the following:

- Colour or brightness should contrast against the background so that they are easily distinguishable.
- Should have an outside diameter of 45–50mm for ease of grip.
- Should be continuous and fitted with ‘returned ends’ continued a minimum of 0.3m beyond the top or bottom of the ramp or staircase.
- Should not project into the minimum clear width of the stair, ramp or corridor.
- Should be robustly fixed.
- Balustrades should be designed to provide physical and visual security.

Doors

See BS8300 and Approved Document M.

Design

The number of doors in a building should be kept to a minimum, since doors obstruct movement through a building for many disabled people as well as people with large sports bags. Doors may be

heavy or awkward to operate if not properly designed and specified. Where they are unavoidable they should comply with the following guidance:

- All doors need to be designed to provide at least the minimum clear door opening appropriate to the type and scale of the facility ref Table 5 and Approved document M.
- Double doors must have at least one leaf that provides the minimum clear opening capable of allowing passage of a wheelchair without having to use the second leaf.
- Wherever possible, all doors should be single swing rather than a double swing action. Doors should not be provided with rebated meeting styles, which are more difficult to negotiate.

Location

- Locate all doors so that there is clear wall space of at least 0.3m to the leading edge side. Ideally – and for sport-specific situations – this should be increased to 0.5m.
- All doors should be designed and located so that they can swing to at least 90°, to ensure maximum door opening - see Fig 10.
- Doors should swing into rooms, not into corridors. Where unavoidable, doors swinging into a corridor should be fully recessed or protected by guardrails that lead people away from the door swing. Any guardrail must not restrict the minimum clear width of the corridor.

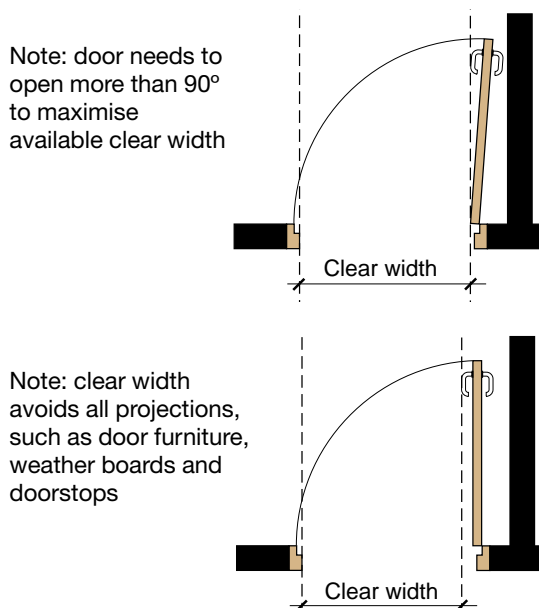

Figure 10 Doors – clear widths

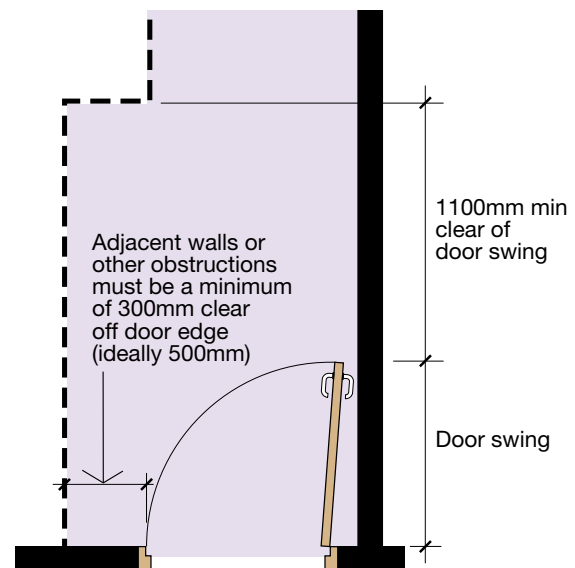

Figure 11 Doors – side clearances

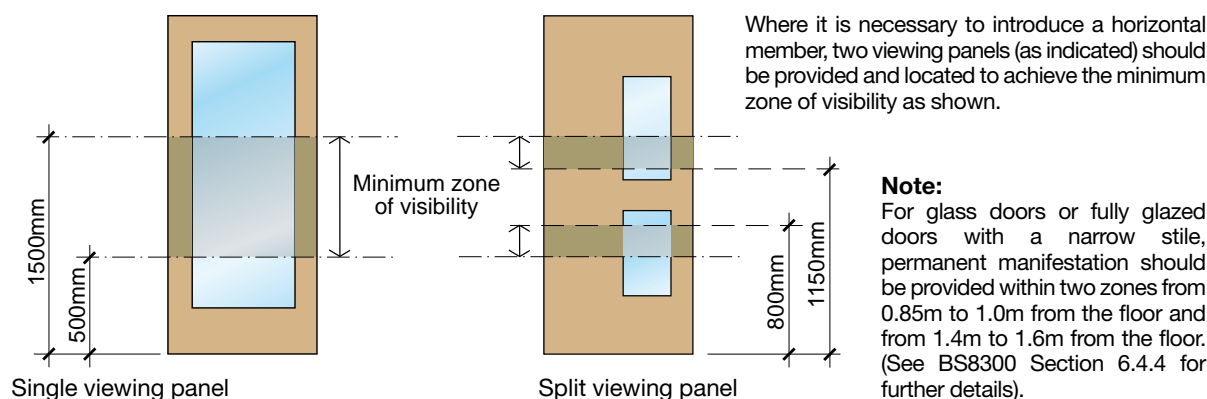

Figure 12 Doors – location of vision panels

Appearance

- Vision panels should be fitted to doors to minimise collisions. The vision panels should allow viewing of adults, children and wheelchair users on the other side of the door.
- Position vision panels as recommended in Approved Document M so that they accommodate people’s eye levels when standing and sitting. See Fig 12 above.
- Fully glazed doors can be a hazard to blind

and partially sighted people. Fully glazed doors should be clearly identified by contrasting bands of manifestation or colour logos. Equally, they should be clearly distinguishable from any adjacent glazing.

- It is important that visually impaired people can identify the door. The most effective way of achieving this is for the door colour to contrast with that of the wall.
- The leading edge of the door should be highlighted to contrast with the rest of the door so that it is more easily detected when the door is open.

Minimum clear width	Clubhouses/pavilions generally, except those serving tennis, athletics or outdoor basketball	Full-size synthetic pitch	Multi-use games area	Fitness equipment room	Four-court sports hall ^{1, 3}	Six-court sports hall ^{1, 3}	Nine-court sports hall or larger ^{1, 3}	Cricket indoor ¹	Gymnastics hall	Tennis indoor ¹	Tennis outdoor ¹	Basketball outdoor	Bowls indoor	Bowls outdoor	Table tennis centre	Athletics indoor	Athletics outdoor	20m swimming pool	25m swimming pool	50m swimming pool
875mm	●	●	●	●	●	●	●	●	●	●	●	●	●	●	●			●	●	
1200mm ²					●	●	●	●	○	●	●	○	○	○	○	●	●	○	○	●

Key: ● Required ○ Recommended

Notes

¹ For 4,6 and 9 court, cricket indoor, tennis indoor and tennis outdoor facilities the minimum clear effective width should be 1200mm in ‘sports chair zones’ and 875mm min for all other doors in the facility

² Unless the 1200mm width can be achieved with automatic powered sliding doors the effective clear width of 1200mm should be achieved by two doors so that when only one door is open a minimum clear effective width of 875mm is achieved.

³ Note where a sports hall is located above ground level the ‘sports chair’ zone will extend from ground floor level up to the floor level where the sports hall is located and therefore any lift doors etc will need to provide the 1200mm clear effective width

Table 5 Internal doors – requirements (except accessible toilets and changing rooms)

Door Closers

Doors can act as barriers if great force is required to overcome the door closer. The door closer should be set to the minimum force necessary to close the door - see BS8300 section 6.5.2.

- Specify and install door closers to minimise the effort needed to open the door.
- Do not set door closers at a high force level in order to overcome badly fitting hinges or smoke seals.
- Doors that are easy to open benefit everyone and are less likely to be damaged.
- Wherever possible, use electromagnetic catches linked to the fire alarm to hold the door open during normal use.
- In large facilities and in those where significant numbers of disabled users are anticipated, consider installing automatic internal doors, either linked to a sensor or to suitably located push pads.

Door Furniture

- Wherever possible doors should be fitted with ironmongery to facilitate use by push or pull operations.
- If it is necessary to install a door catch or lock rather than a latch mechanism to hold the door closed, use a lever handle. Doorknobs should be avoided as they are difficult to grasp.
- Door handles and pull handles should be located at a comfortable height for wheelchair and ambulant users as set out in BS8300.
- Door handles and pull handles should contrast with the door.
- Use escutcheons that contrast with the face of the door to aid location of keyholes.
- Provide a door pull on doors where no external handle is fitted so that it is not necessary to use the door key to pull open the door.
- Do not use 'break glass' emergency bolts as they are obstacles for people with disabilities. Large push pads, which can be alarmed if necessary, should be used to allow speedy departure from the building.



Lifts

See BS8300 and Approved Document M.

Passenger lift

A lift for general access should be located close to the reception and main circulation routes. The lift specification is as follows:

- The lift must conform to the requirements of BS EN 81-1, BS EN 81-2 and BS EN 81-70
- In all but the smallest multi-storey facilities, at least 2 general access lifts should be provided to ensure that users are not inconvenienced / stopped from using the facility if one lift breaks down or is being serviced.
- The lift door must have a clear opening width appropriate to the size and scale of the facility and the type of wheelchairs to be used (See Table 7).
- For sports facilities that will not include wheelchair sports, the internal lift space must be at least 1.1m wide x 1.4m clear depth internally and preferably 2.0m wide and 1.4m deep.
- Where the lift is part of the 'sports chair zone' the lift door will need to provide a clear opening of 1.2m to accommodate the large sports chairs.

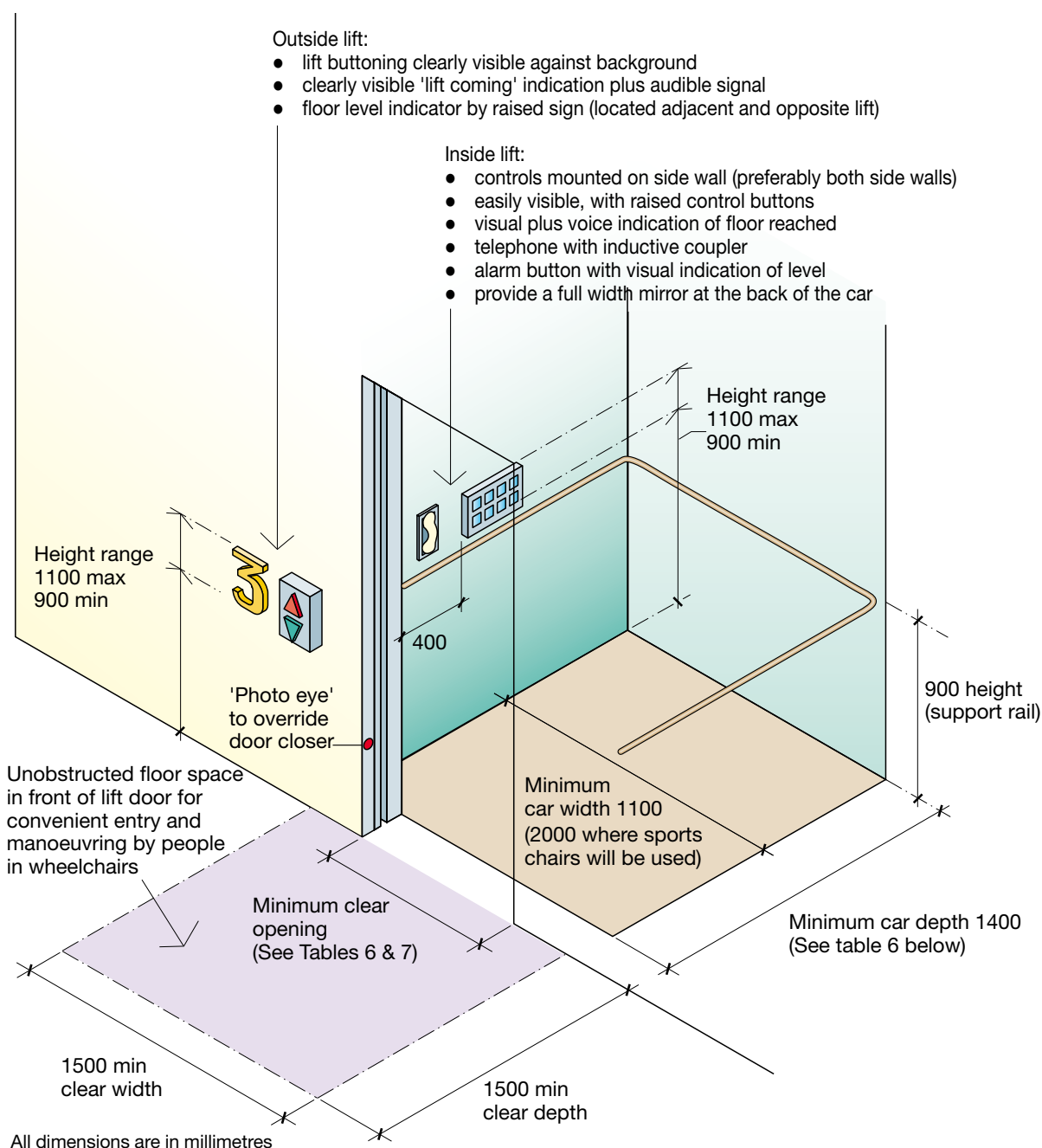

Notes:

- Lift doors should remain open for five seconds to allow adequate time for entry.
- Lift doors must be easily distinguishable from the adjoining wall.
- Consider fold-down seats in larger lifts.

Figure 13 Lift – Critical Details

Passenger Lift capacity	Load Kg	Car Width mm	Car length mm	Door Width mm (clear)
8 ¹	630	1100	1400	900
17 ²	1275	2000	1400	1100 ²

Notes:
Through lifts (lifts with doors at both ends of the lift car) are available from most passenger lift manufacturers. These allow wheelchair users to enter and leave without reversing, but will impact upon the building layout. In all but the smallest multi-storey sports halls, at least 2 general access lifts should be provided.

¹ An 8 person passenger lift is the smallest size that will meet the requirements for an accessible lift, but can only carry one wheelchair at a time.

² Where the lift is part of the 'sports chair zone' (see Figure 7), the lift door will need to provide a clear opening of 1200 to accommodate the large sports chair and an appropriate increase in car size.

Table 6 Accessible Passenger Lift Car & Door Sizes - Minimum Requirements

- If the minimum car size is used, consideration should be given to a through car where it is possible to enter and exit in a forward direction.
- Otherwise, a mirror should be provided on the back wall of the lift to assist the wheelchair user who has to reverse out of the lift.
- For sports facilities where there will be wheelchair sports lift, the lift size should be 2.0m wide and 1.4m deep to accommodate at least two wheelchairs at a time.
- Within the car and at each landing there should be audible announcements and a clear visual display of the level reached.
- The lift controls should be clearly distinguishable, easy to operate and be within reach of wheelchair users. The buttons should have tactile numerals and symbols.
- Within the car the controls should be located on a side wall.
- Light fittings within the lift car should be located so that they do not cause glare; there should be a minimum light level of 100 LUX at floor level.
- Accurate levelling at landings is critical. This is dependent on regular maintenance.
- There should be a minimum five-second delay to the lift door closing mechanism.
- Consider providing a fold-down seat in larger lifts.
- An alarm button should be provided, with a repeater light to show that the alarm bell has sounded. An additional button that can be reached from floor level should be provided.
- The emergency communication system in the lift should incorporate inductive couplers to assist hearing aid users.
- In association with the fire officer and/or building control officer, agree whether the lift is to be designed and designated for use for emergency purposes (See Section 6.0 and BS 9999:2008).
- Where lifts are located in separate fire compartments, they may, subject to agreement with the Fire Officer and risk assessment, be used for emergency evacuation (See Section 6.0 and BS 9999:2008).

At each floor level:

- There should be clear space of at least 1.5 x 1.5m in front of the lift.
- Opposite and adjacent to the lift there should be clearly visible signs with raised numerals/ letters indicating the floor level.

Minimum clear door width into lift (mm)	Clubhouses/pavilions (serving only natural turf pitches)	Clubhouses/pavilions generally	Full-size synthetic pitch	Multi-use games area	Fitness equipment room	Four-court sports hall **	Six-court sports hall **	Nine-court sports hall or larger**	Cricket indoor	Gymnastics hall	Tennis indoor	Tennis outdoor	Bowls indoor	Bowls outdoor	Table tennis centre	Athletics indoor	Athletics outdoor	20m swimming pool	25m swimming pool	50m swimming pool
900 *	●	●	●	●	●	●	●			●			●	●	●	●	●	●	●	●
1100 *						○	○	●	●		●	●				○				○
Short-rise vertical platform lift	▽	▽	▽	▽	▽					▽		▽		▽	▽			▽		
Key: ● Required ○ Recommended ▽ May be acceptable																				
* Where the lift is providing access between 'Sportchair Zones' the lift should have an effective clear opening width of 1200mm																				
** Note where a sports hall is located above ground level the 'sports chair' zone will extend from ground floor level up to the floor level where the sports hall is located and therefore any lift doors etc will need to provide the 1200mm clear effective width.																				

Table 7 Lifts – minimum clear door width requirements

Vertical platform

In exceptional circumstances where a passenger lift cannot be accommodated and there is limited wheelchair use, short-rise vertical platform lifts are acceptable in small facilities. These lifts can be particularly useful in existing buildings where a significant change in level would necessitate an extensive ramp arrangement or where space is limited. Note the following details:

- Enclosed platform lifts should conform to ISO 9386-1
- Non-enclosed platform lifts should conform to BS 6440
- Minimum clear platform size must be 1.1m wide x 1.4m long
- Platform lifts have limited platform size and can only accommodate one wheelchair at a time. They are not suitable for sports facilities catering for large numbers of wheelchair users.

Wheelchair stair lift

A wheelchair stair lift is not an acceptable means of access for any type of sports facility and could be a hazard if fitted on escape stairs.



6.0 Emergency Escape

Detailed guidance on means of escape for disabled people is given in BS 9999:2008 Code of Practice for fire safety in the design, management and use of buildings, Section 9 part 46 Evacuation of disabled people. The main requirements for a sports facility are set out below.

Planning

Give detailed consideration to how disabled people will be evacuated from the building at an early stage of the project. Their safe and successful evacuation is dependent upon:

- Management arrangements
- Layout, in particular the 'sports chair zone' where users could be using large sports chairs
- Construction of the building.

These three issues cannot be dealt with in isolation even in the smallest facilities. Early consultation should take place, initially between the architect and the building manager, to establish:

- The physical features that can be used to support means of escape of disabled people
- The numbers of staff that might be available to provide assistance
- The communication systems that can be put in place to ensure that this information is conveyed to all disabled people using the building.

Using this information an outline fire plan evacuation strategy should be developed. In all but the smallest projects the architect should then consult with the building control officer and the fire officer to obtain advice and guidance on the proposed building and evacuation strategy. In larger projects a fire consultant may be required in order to prepare a Fire Engineered solution.



Disabled people

It is not possible to accurately determine the numbers of disabled people that will use the building; however it is likely that they will include the following:

- Mobility-impaired people
- Wheelchair users
- People who are deaf and hard of hearing
- Blind and partially sighted people
- People with cognitive disabilities
- People with unseen health disabilities such as asthma.

Each of these groups of people may require either:

- suitable physical features to enable them to exit independently
- assisted evacuation.

The number of disabled people will however depend upon the type of facility proposed. Facilities designed to cater for training for events such as the Paralympics will inevitably attract a high number of disabled people, not just as competitors but also as spectators.

Early in the design process it is important to recognise the cost of providing staff to assist escape rather than taking inclusive design features into the escape routes.

Multi-storey buildings

In a multi-storey building great care should be taken to ensure that management of the facility takes account of disabled people's requirements – especially with regard to emergency evacuation.

A sports facility must be accessible to everyone. Evacuation procedures need to allow everyone to make their way to a place of relative safety protected from fire and smoke whatever floor they are on.

The place of safety should be considered as the first part of their escape and an opportunity to buy time for them to exit the building safely.

With the right physical features, many disabled people, including wheelchair users, will be able to get out of the building under their own steam. Sometimes however this may be slower than the majority of the people in the building. It is important therefore that they are able to use the safest

escape route to make their descent; the opportunity to do this will need to be facilitated by good communication and information regarding the nature, extent and position of the emergency.

In the event of a false alarm, it is important that disabled people leaving the building are advised of this as soon as possible so that they can stop their descent and wait for further instruction.

Where assisted escape is the only option for a person then this should be provided through the management of the building. It should not be left to the fire service to provide assisted escape and their duties when attending the fire will be:

- life safety
- immediate fire control
- rescuing people who are not at immediate risk.

Fire evacuation

An Evacuation strategy must be based on a risk assessment and must ensure that:

- Every part of the building has a safe means of escape in emergencies.
- Every escape route is fully usable by everyone, including people with disabilities wherever practicable.

Evacuation plans

Evacuation plans need to define comprehensive management procedures for the evacuation of all occupants including disabled people:

- Establish procedures to ensure people are aware of where assistance can be obtained if needed.
- All fire exits on the ground floor should have level or ramped access.
- Where there is spectator seating the design should provide a means of escape for disabled spectators.
- The number of disabled people using a sports facility may vary significantly according to the nature of the use, ranging from an individual user to large numbers of participants, spectators and officials at large competitions. The evacuation plan should anticipate these situations and ensure the adequacy of the building design and of management procedures.

The use of personal emergency evacuation plans (PEEPs) is recommended for all people requiring

assistance to leave the building. Details of three types of PEEP are given in clause 46.7 of BS 9999:2008 Section 9.

Refuges

The design should incorporate 'refuges' on escape routes serving for example flights of stairs or an evacuation lift. Refuges are places of relative safety where disabled people can wait for short periods of time before making their way to the final exit or await assistance to the final exit.

If possible, the fire compartmentation of the building should be used to provide a means of horizontal evacuation to a place of safety. Ideally, each fire compartment should be served by its own lift so that a full evacuation can be achieved.

Where progressive horizontal escape is provided it is important that the building orientation system reflects this. See Annex G of BS 9999:2008.

Existing buildings may have spaces that can be used as refuges without the need to create new areas.

The minimum size for a refuge is 0.9m x 1.4m except in facilities such as sports halls that are likely to accommodate sports chairs. In such cases the minimum size is 1.2m x 1.5m.

A refuge of suitable size should be provided at each floor level for every fire escape staircase. The refuge area must not restrict the escape width.

In large, complex sports facilities it is essential that the responsible person/fire officer can communicate with people occupying refuge areas. The specification of a suitable intercom system should comply with BS5839:2003 and be agreed with the fire officer at an early stage in the project's development. Where a refuge is located in a lobby or stairway a 'Refuge – Keep Clear' sign should be displayed.

Evacuation lift

To operate in the event of fire, an evacuation lift should:

- Be a passenger lift that is always available for evacuation purposes.
- Be designed in accordance with BS 8300, BS EN 81-1 or BS EN 81-2 and BS EN 81-70 and BS9999:2008.
- Have its own independent electrical supply and control.
- Be clearly signed.
- Be located so as to be associated with a refuge and escape stair.
- Be within a protected enclosure, that is, the lift shaft itself and have protected lobbies at each floor level and a direct route to the outside at the exit level.

In a building over two storeys, install a communications system to relay information to the person operating the lift car.

Note that a goods lift should not be used for people movement under any circumstances.

Where a lift of any kind is provided in a compartment not effected by the emergency then it may be possible to use this if a suitable Risk Assessment is provided.

Sounders / alarms

In large facilities supplement audible alarms with approved flashing beacons for people with a hearing impairment. The beacons should be located in areas where people with a hearing impairment might find themselves alone and unaware of an emergency evacuation alarm. Flashing beacons must be located so that they are within the line of sight.

It is important that all members of staff are properly trained so that they take appropriate steps when a person does not react as expected by using suitable communication techniques.

In smaller facilities consideration should be given to providing personal vibrating pagers linked to the alarm system. Vibrating pager systems are particularly useful for deaf staff, who may work on their own anywhere within a sports complex.

Where digital visual information display systems are provided these can be connected to the alarm systems and display information including evacuation alerts. Where assistive hearing systems

are provided these can also be programmed to transmit means of escape information.

In larger facilities, two-stage alarm systems may be utilised. The first stage being a staff 'Alert' enables them to put into action the planned response. This could be the evacuation of the area in immediate danger, ensure that people unable to leave the building unaided are assisted to refuge areas etc. The second alarm would signal the full evacuation of the building.



7.0 Changing Areas

All changing areas must be designed so that disabled people can use them. This does not necessitate expensive design features but it does require attention to detail and layout. All sports facilities, except those serving only grass pitches, must provide at least one individual unisex

accessible changing room complete with shower and toilet. This enables assistance to be given by someone of either sex.

Key design requirements are set out below. For sport-specific requirements see the later sections.

Note:

It is intended that CAD drawings of figures 16-20 and figures 22-25 are going to be made available for download from the Sport England website.

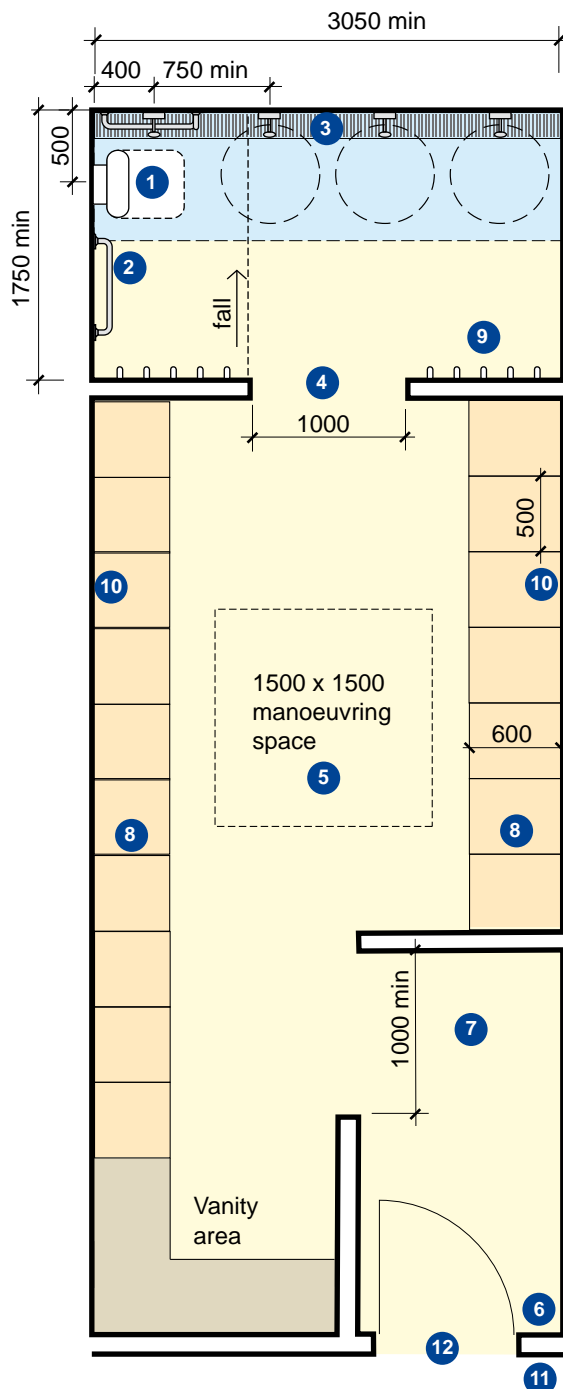

Key

1. Robust 500 x 500mm shower drop-down seat with horizontal and vertical grabrails to give extra support to users
2. Horizontal grabrail in drying area gives extra support and can be used as a towel rail
3. Simple, safe falls to drainage channel
4. Level threshold between changing and shower areas
5. 1500mm minimum manoeuvring space to be maintained in the changing area in front of benches and fittings
6. Minimum 300mm clear (500 preferred) from door leading edge to wall
7. Entrance lobby provides privacy by screening the changing area but maintains the minimum clear width of 1000mm
8. Benches 450mm minimum depth (500 preferred) set at height 480mm with a smooth finish to surfaces and edges. Also provide run of 600mm deep benches to some areas
9. Towel hooks in shower located at 1400mm
10. Locate coat hooks above benches at 1400 and 1050mm
11. Locate signs on wall adjacent to door edge to allow easy identification of the changing facilities
12. 1026mm door to achieve minimum clearance requirement of 875mm

Note: All dimensions are in millimetres

Figure 14 Accessible Team Changing Facilities

Main changing areas

Layout

A well-designed layout is critical to achieving maximum accessibility. Careless design can reduce a person's independence and, at worst, physically prevent use of a facility. It is essential that:

- Sufficient space is provided for wheelchair users to manoeuvre.
- Allowance is made for a wheelchair user to change without obstructing other users.
- Direct access is provided to the shower area from the changing room.
- Toilet provision is in very close proximity to the changing area.

Some disabled users may prefer the privacy of an individual cubicle and, wherever possible, these should be provided.

Where significant wheelchair use is anticipated, for example where wheelchair team sports could be played, the layout and design of the changing area should reflect this. This may include:

- An individual accessible changing cubicle or cubicles within the main 'team' changing area, which can double up as family changing to allow personal privacy within the team context.
- Where appropriate these individual accessible cubicles should be fitted with support facilities such as hoists and additional handrails.

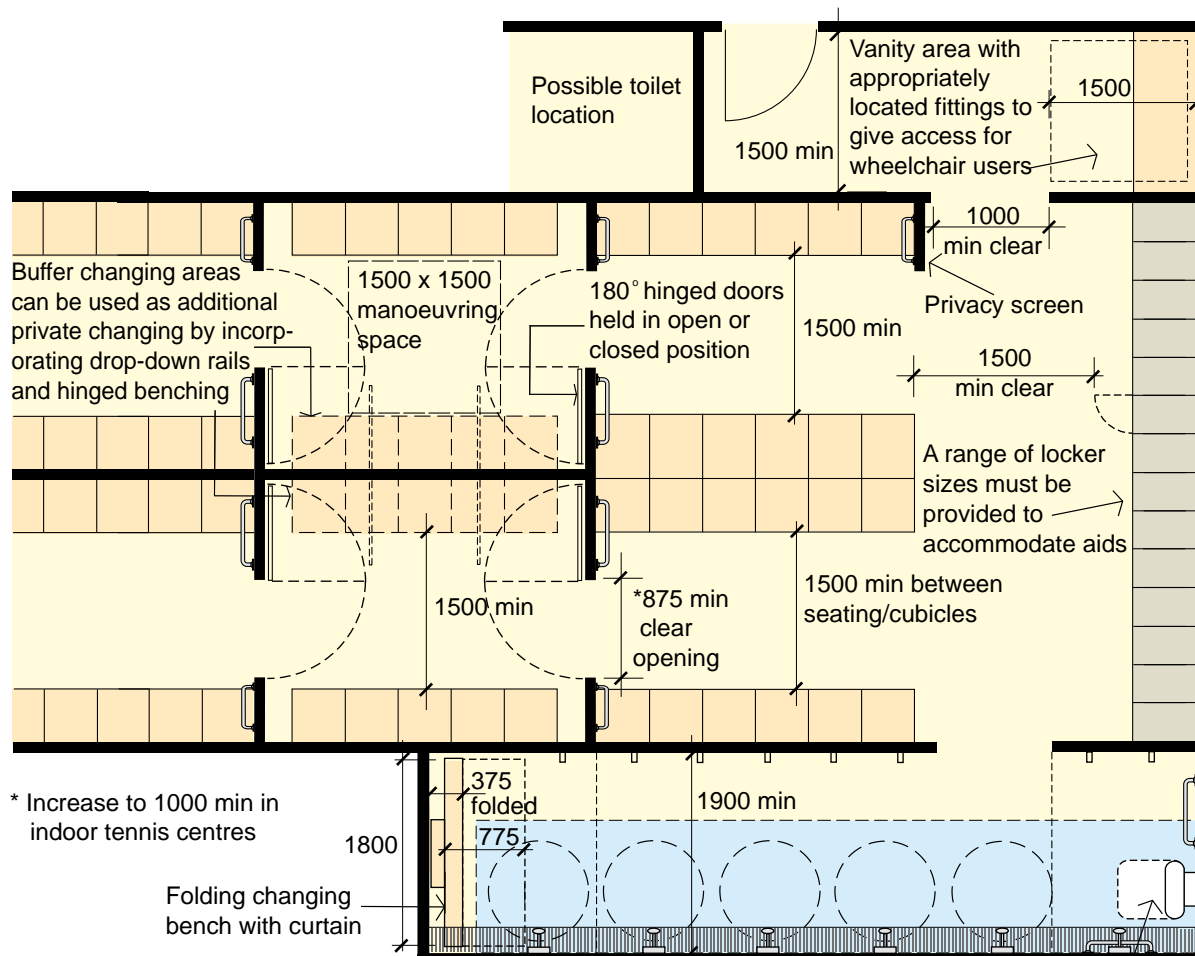

Note: All dimensions are in millimetres

Figure 15 Accessible Group Changing Facilities

Benches

- All benches must have a minimum depth of 0.45 – preferably 0.5m – and be set at a height of 0.45m to allow easy transfer from a wheelchair.
- For assisted changing for an adult, a length of bench at least 0.6m deep by 2.0m long should be provided within the main changing areas.
- Additional non-toxic foam matting may be necessary to lay over the benching as extra protection for people with sensitive skin. The matting should be kept readily available in a convenient store.
- Where wheelchair competition events are likely but infrequent, consider making some benching movable to provide temporary additional manoeuvring space for extra wheelchair users.
- Sports facilities commonly incorporate ‘buffer’ changing spaces to accommodate peak demand on changing provision. When not required for general changing, well designed buffer spaces can provide additional private changing for disabled users.

Coat hooks

- Alternate coat hooks should be located 1.05m and 1.4m above floor level to enable use by children and wheelchair users.

Lockers

- Sufficient lockers should be set at heights between 0.45m and 0.9m and be at least 0.3m wide. A proportion of lockers should be 0.4m wide to accommodate sports bags.
- Ten per cent of lockers should be ‘full-height’ lockers at least 1.8m high to accommodate mobility aids and so on.
- Locks must be positioned at 1.15m maximum above the floor and be easy to operate by a person with poor dexterity or limited hand or arm strength. Where stacked locker compartments are used, locks to the upper cubicles need not be limited to 1.15m provided that there are sufficient numbers of lockers accessible to disabled users within the locker runs.
- Locks and lockers should have clearly visible and embossed numbers that can be read by sight or touch.
- Where there are large banks of lockers some form of orientation assistance should be given, for example by using very strong colour

contrasts and/or symbols and by replicating this as part of the key design, for example, by zoning areas with the use of colour.

Equipment

Shower wheelchairs

- Self propelled shower wheelchairs should be readily available. These are essential for use in showers and other wet areas and to provide access to the swimming pool.
- In facilities where there is a hoist assisted large changing room and several shower wheelchairs are provided, one should be of the commode type for use with a WC.
- There should be enough floor space to enable the users to transfer from their own wheelchair onto the shower chair.
- A suitably designed space should be provided within all changing areas for the safe, convenient and secure storage of shower chairs and personal wheelchairs.

Hoists

For a large number of people, transfer to and from their wheelchair can only be achieved with the aid of a hoist in the changing room environment.

Two types of hoist are available, ceiling track hoists and mobile hoists. Where installation is possible, a ceiling track hoist should be provided in preference to a mobile hoist as it is easier to use. Also it cannot be removed from the room in which it is needed.

- **Ceiling track hoists:**

Ceiling hoists run along permanently fixed tracks, so they offer less flexibility in use than a mobile system. However, they do not occupy floor space as does a mobile hoist. They are also easier to use.

The flexibility of the ceiling hoist can be increased by the use of an ‘H’ track that gives access in the hoist to a larger area of the room.

- **Mobile hoists:**

Mobile hoists do not require any track installation; they are more flexible in use. However, they are more difficult for the personal assistant to use. They should not be used for moving people long distances. A mobile hoist will also require appropriate storage when not in use.

It is also important to check that the hoist has sufficient capacity to lift the heaviest people using the facility, and an operating range to lift the person clear of any surface, and perhaps also to pick them up from floor level in an emergency, although this should be left to a medically qualified person.

A mobile hoist should be available as indicated in Table 11 on page 61.

- **Slings:**

Both types of hoist require a sling in which to carry the person being transferred. A person who relies on the use of a hoist for transfer may well have their own sling; however, this may not be compatible with the hoist available.

Whilst people should be encouraged to bring their own slings, a range of slings should be available within the facility to cope with people of different sizes and weights. They should be securely stored when not in use. In order to limit risk of infection, slings must be kept clean and washed after each use.

Hairdryers/mirrors

- Hairdryers and mirrors should be provided above shelves in the vanity areas of changing areas. For universal use, the hairdryer controls should be set at 1.1m maximum above floor level.
- Mirrors over shelves in grooming areas should be 1.0m high by 0.5m wide and positioned so that the top is 1.9m above the floor level.

Heating

To avoid accidental burns heating surfaces should be carefully located and fitted with thermostatic controls. Radiators and radiant tubes, for example, should be low surface temperature type, fitted with cover or positioned out of reach (e.g. ceiling panels).

Unisex accessible changing

Provision

The minimum provision for accessible changing is indicated in Table 8, however consideration should be given to the provision of additional spaces to meet likely demand. Generally, unisex accessible changing facilities should be provided in addition to other accessible provision.

- Dedicated accessible changing areas allow a helper from either sex to provide assistance in privacy.
- Each room needs to contain a tip-up seat,

shower, WC and washbasin and meet the dimensional criteria set out in Figure 16.

- Unisex accessible changing rooms should be clearly signposted.
- Layout and relationships to other areas are critical.
- Dedicated lockers should be located immediately outside the accessible changing to allow access by more than one person and avoid the risk of vandalism.
- The number of accessible changing rooms provided will depend on the type and scale of the facility (see Table 8).
- The design and quality of the accessible changing area should be similar to the other changing facilities; fittings should contrast clearly with their background.

Larger unisex accessible changing cubicle

- For sports facilities where there is likely to be a demand from more severely disabled people, an additional larger, unisex changing cubicle with WC, basin shower, changing bench and ceiling hoist should be provided.
- Recommendations for the provision of larger changing cubicles are made in Table 8.
- The criteria for dimensions and equipment of the larger cubicle is shown in Figure 19.
- Where more than one larger changing cubicle is provided it may be appropriate to use a mobile, height adjustable changing bench rather than a stationary bench.

Showers

- All shower areas must be usable by everyone. An area designed to meet the needs of disabled users will accommodate use by non-disabled people.
- Except in small pavilions serving only one natural grass pitch, all shower areas should be fitted with at least one drop-down seat and appropriate grab rails. The seat should fold up out of the way when not required.
- Shower seats should not be fitted with vertical support struts as these impede access.
- At large facilities, in addition to providing the fixed tip-up shower seat a mobile shower chair should be provided and an area provided where the chair can be safely and conveniently stored.

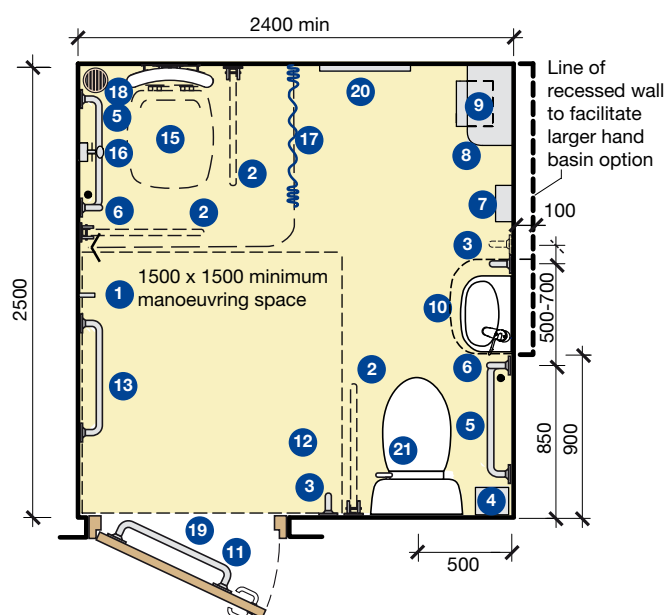

Note: All dimensions are in millimetres

Figure 16 Unisex Accessible Changing Room

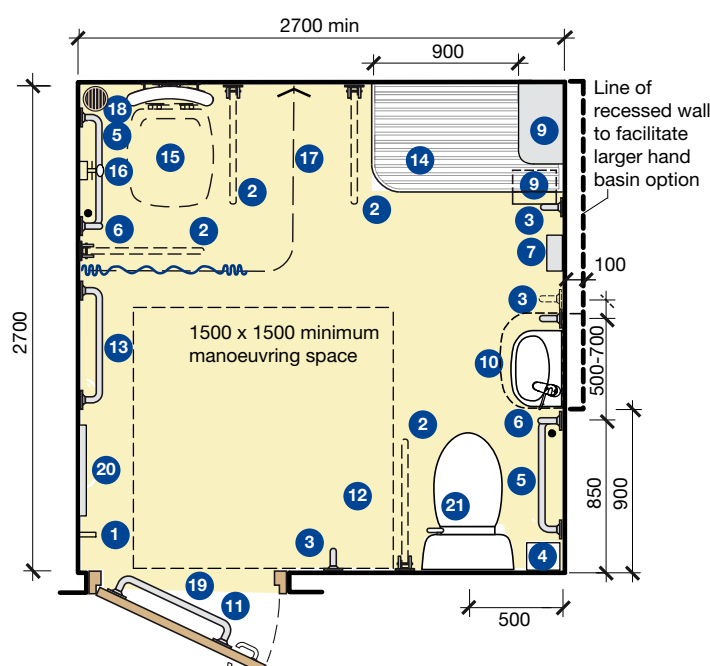

Note: All dimensions are in millimetres

Figure 17 Unisex accessible changing room with fixed changing bench seat

If two changing rooms of these types are to be provided they should be mirrored to allow for left hand and right hand transfer

Refer to Figure's 18 & 26 for key setting-out dimensions for WC and basin and Figure 21 for shower wall elevation

Key

1. Two clothes hooks set at 1400mm and 1050mm above floor level
2. Drop-down rail (without toilet roll holder)
3. Fixed vertical rail
4. Colostomy changing shelf for ambulant users 950mm above floor level
5. Fixed horizontal grabrail
6. Fixed vertical rail and adjacent alarm pull-chord with two red triangles
7. Automatic hand dryer
8. Low shelf with rounded corner
9. Disposal bin for miscellaneous items with sanitary dispenser above (750-1000mm above floor level)
10. Hand basin can be recessed in order for a larger basin to be used (as an alternative to a standard small basin) The thermostatic mixer tap to be located on the WC side of the basin.
11. Horizontal door pull to enable door to be closed when entering
12. It is essential to keep the area adjacent to the WC clear to allow side transfer onto the WC
13. Fixed horizontal grabrail used as towel rail
14. 600mm deep fixed seat bench with rounded corner and soft round edges
15. Padded tip-up shower seat with back rest. Front edge set 600-700mm from back wall to allow lateral transfer
16. Shower controls - lever-operated, thermostatically controlled (max 41 degrees centigrade)
17. Shower curtain and rail
18. Floors laid with simple falls to flush gully or grating
19. 1026mm door to achieve minimum clearance requirement of 875mm
20. Mirror 1500mm high, located 600mm above floor level
21. WC: flush lever to wheelchair transfer side; transferring from a wheelchair to a WC imposes significant forces, therefore all fittings must be robust. Wing nut fixings should not be used to secure the toilet seat.

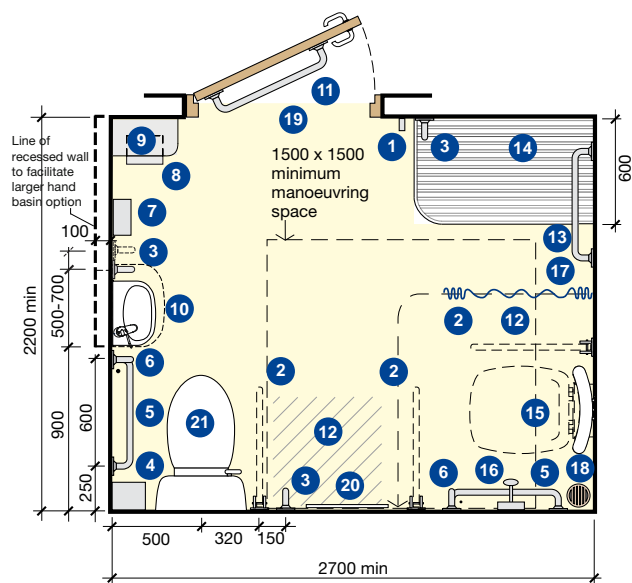

Note: All dimensions are in millimetres

Figure 18 Unisex accessible changing room with shower, WC and fixed bench seat

Notes:

If two changing rooms of these types are to be provided they should be mirrored to allow for left hand and right hand transfer

Refer to Figure's 26 for key vertical setting-out dimensions for WC and basin and Figure 21 for shower wall elevation

Key

1. Two clothes hooks set at 1400mm and 1050mm above floor level
2. Drop-down rail (without toilet roll holder)
3. Fixed vertical rail
4. Colostomy changing shelf for ambulant users 950mm above floor level
5. Fixed horizontal grabrail
6. Fixed vertical rail and adjacent alarm pull-chord with two red triangles
7. Automatic hand dryer
8. Low shelf with rounded corner
9. Disposal bin for miscellaneous items with sanitary dispenser above (750-1000mm above floor level)
10. Hand basin can be recessed in order for a larger basin to be used (as an alternative to a standard small basin) The thermostatic mixer tap to be located on the WC side of the basin.
11. Horizontal door pull to enable door to be closed when entering
12. It is essential to keep the area adjacent to the WC clear to allow side transfer onto the WC
13. Fixed horizontal grabrail used as towel rail
14. 600mm deep fixed seat bench with rounded corner and soft round edges
15. Padded tip-up shower seat with back rest. Front edge set 600-700mm from back wall to allow lateral transfer
16. Shower controls - lever-operated, thermostatically controlled (max 41 degrees centigrade)
17. Shower curtain and rail
18. Floors laid with simple falls to flush gully or grating
19. 1026mm door to achieve minimum clearance requirement of 875mm
20. Mirror 1500mm high, located 600mm above floor level
21. WC: flush lever to wheelchair transfer side; transferring from a wheelchair to a WC imposes significant forces, therefore all fittings must be robust. Wing nut fixings should not be used to secure the toilet seat.

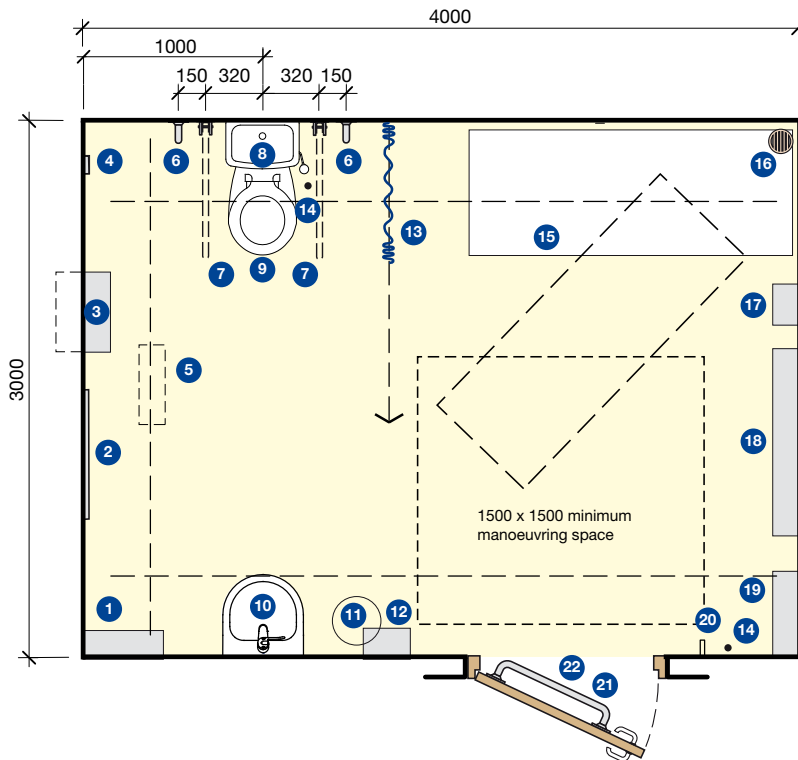

Key

1. Paper towel dispenser
2. Mirror 1500mm high, located 600mm above floor level
3. Large sanitary disposal bin, if possible recessed into the wall
4. Alarm reset button
5. Full room cover tracked hoist system
6. Fixed vertical grab rail
7. Drop-down support rails, one with a toilet roll holder
8. Flat-topped close-coupled cistern providing a back rest and a colostomy changing surface for standing users (where high or low level cisterns are used, a rail with a padded back rest and a separate colostomy changing shelf 125 mm to 150 mm deep and preferably 400 mm wide, with its surface 950 mm above floor level, should be provided)
9. Peninsular WC (see Figure 55 of BS8300 for the location of associated fittings)
10. Large power-assisted height-adjustable washbasin
11. Waste disposal bin
12. Manually-operated hand dryer
13. Retractable privacy curtain/screen
14. Alarm pull cord
15. Height-adjustable showering / changing bench, min. 1800 mm long
16. Floors laid with simple falls to flush gully or grating
17. Shower unit
18. Wide paper roll dispenser for use on the changing bench
19. Sanitary towel dispenser
20. Two clothes hooks, one at 1050 mm and the other at 1400 mm above the floor
21. The doorway should comply with BS8300 requirements
22. Horizontal door pull to enable door to be closed when entering

Note: All dimensions are in millimetres

Figure 19 Unisex 'Changing Places Facility' (see BS8300 figure 58) where assisted change is to be provided.

Notes:

- This is additional provision: see Table 8 of this guidance note
- Refer to notes on following pages 43-44, extracted from BS8300

Extracts from BS8300, Section 12.7

Changing Places sanitary accommodation

A Changing Places (CP) facility is a combined toilet, shower and changing room for use by people with complex and multiple disabilities who require the help of up to two assistants. The space needs to be fitted with a fixed tracked hoist system so that assistants can fit the user's slings to the hoist and move the person to the various items in the facility. CP facilities require extended space to accommodate disabled people, often with large complex wheelchairs with elevated leg rests, a reclining facility or integral oxygen cylinders, and space to fit slings for use with the hoist. It also needs to be possible for a wheelchair to be parked within the facility when not in use without compromising the safe access and use of the equipment.

As CP facilities are not designed for the use of independent wheelchair users, or to be used as baby changing facilities, it is desirable for facility providers to indicate the location of the nearest unisex accessible WC and the nearest baby changing facility. Further advice on the design and installation of CP facilities, including a suitable logo to identify such facilities, can be obtained by contacting the Changing Places Consortium

<http://changing-places.org/>

The CP facility should be at least 3.0m wide and 4.0m long, with a ceiling height of 2.4m.

For door requirements refer to BS 8300.

NOTE: Details of common features of sanitary accommodation are described in 12.2 and accessories related to toilets in 12.6.6 of BS8300. Advice on particular products is available from the Changing Places Consortium (see Appendix).

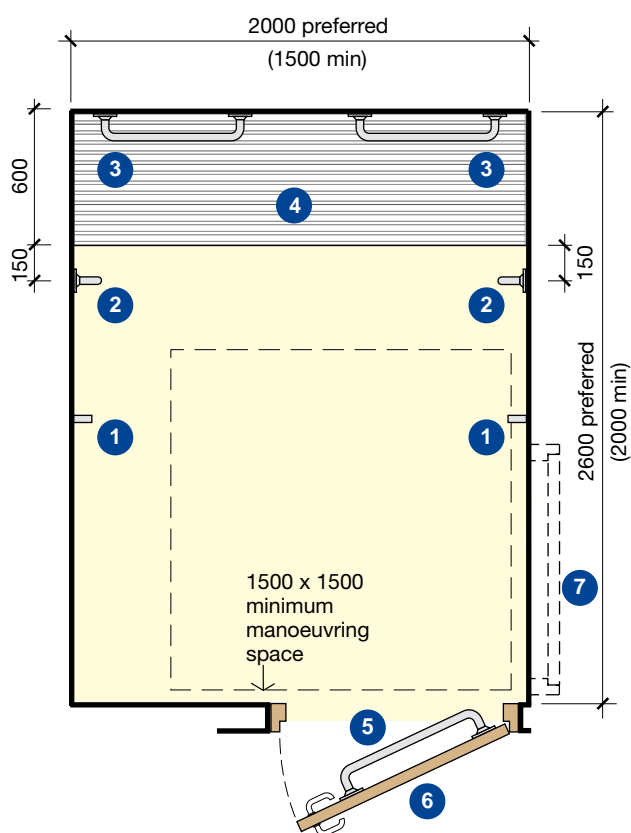

Key:

1. Two clothes hooks set at 1400mm and 1050mm above finished floor level
2. 600mm vertical grab rail securely fixed to side wall and set 800mm from floor level to the bottom of the rail
3. 600mm long horizontal grab rail securely fixed to back wall and set 680mm above finished floor level
4. 600mm deep cantilevered changing bench set at 480mm above finished floor level
5. Horizontal door pull to enable door to be closed when entering
6. Door to achieve minimum clearance requirement of 875mm
7. Alternative door position

Note: All dimensions are in millimetres

Figure 20 Accessible changing cubicle within a main changing room (Ref Table 8, p44)

- Shower controls should be lever-operated and located at an accessible height - see Figure 21. They should be thermostatically limited to a maximum temperature of 41°C to meet the BuildCert/TMV Scheme.
- Floor finishes must be slip-resistant even when wet.
- Water must be contained within the wet areas by the provision of suitable drainage and permanent inset matting.
- Avoid complex falls in the floor that will make standing or manoeuvring a chair difficult and hazardous; the slope should be simple and shallow, no greater than 1:35 and no less than 1:50.
- Upstands separating wet and dry zones must be avoided as they are an obstacle to people with disabilities and a trip hazard to all.
- Design the shower area to allow wheelchair users to transfer between wheelchair and shower seat without getting the wheelchair wet, and so that the wheelchair is still within reach.
- Shower curtains or in larger facilities robust hinged or folding screens should be provided to give additional privacy.

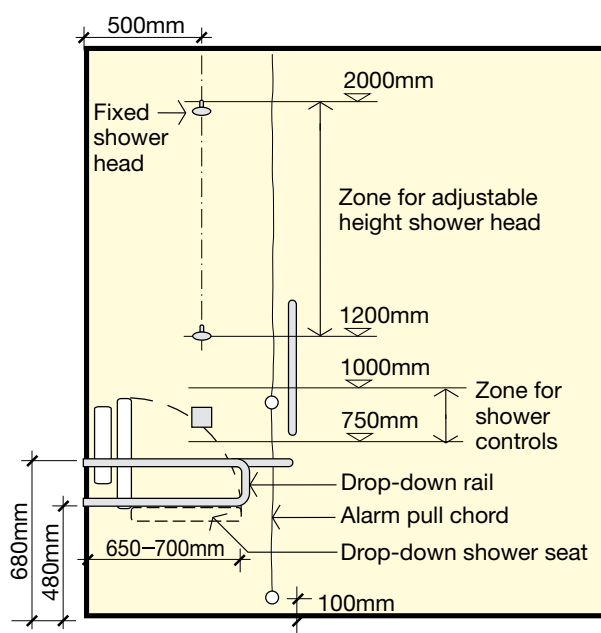

Note: All dimensions are in millimetres

Figure 21 Key vertical dimensions to accessible shower area

Provision	Clubhouses/pavilions (serving only one natural turf pitch)	Clubhouses/pavilions generally	Full-size synthetic pitch	Multi-use games area	Fitness equipment room	Four-court sports hall	Six-court sports hall	Nine-court sports hall or larger	Cricket indoor	Gymnastics hall	Tennis indoor	Tennis outdoor	Bowls indoor	Bowls outdoor	Table tennis centre	Athletics indoor	Athletics outdoor	20m swimming pool	25m swimming pool	50m swimming pool	
One unisex changing room and WC (min) - Fig.16 *	○	●	●	●	●	2	2	2**	●	●	2	●	●	●	●	●	●	●	●	●	2**
In addition provide an accessible changing cubicle within the main changing area - Fig.20	○	○	○	○	○	○	○	●	○	○	○	○				○	○	○	●	●	
Changing rooms large enough for wheelchair teams						●	●	●	●												
In addition provide a unisex 'Changing Places' changing room - Fig 19. (In pools this must be accessible from the main unisex accessible changing area.)								●										○	●	●	
Key: ● Required ○ Recommended																					
Notes:																					
* Fig. 16 is the minimum acceptable arrangement, Fig.'s 17 and 18 are the preferred arrangements.																					
** The above figures are the minimum and should be increased if necessary to reflect the anticipated amount of use and the relationship to the individual facilities																					
General note:																					
Unisex accessible changing facilities must be located wherever there is general changing provision.																					

Table 8 Changing areas – requirements

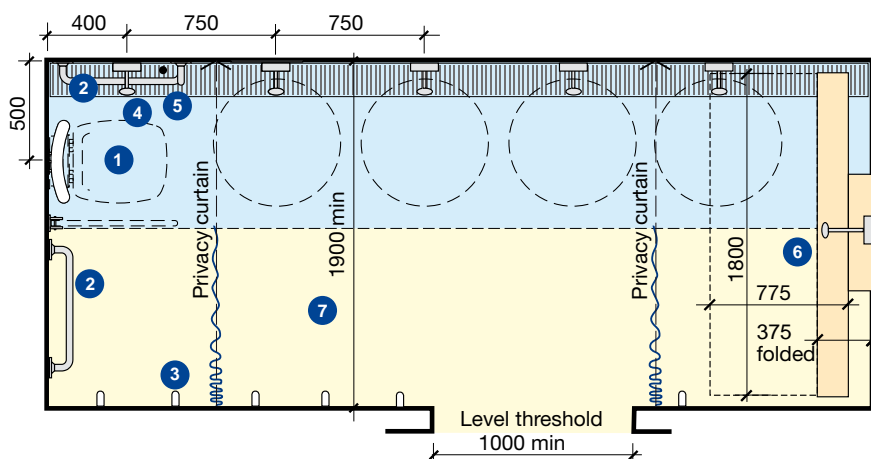

Note: All dimensions are in millimetres

Figure 22 Typical shower area for general use incorporating changing bench

Key

1. 500 x 500mm tip-up shower seat set in corner with grabrail set on shower head wall
2. 600mm long horizontal grabrail providing additional support and can be used as towel rail
3. Towel hooks set at alternate heights of 1400mm and 1050mm
4. Shower controls set at 1000mm above floor level with two shower heads at 1400 and 1800mm above floor level
5. Note: Where practicable, provide a privacy curtain, drop-down grabrail and emergency pull-cord with two red triangles
6. Consideration should be given to the inclusion of an adjustable folding bench together with an adjustable, thermostatically controlled shower.
7. Dry-off area with slip resistant surface laid to simple falls
8. Shower curtain and rail
9. Door to achieve minimum requirement of 875mm clear

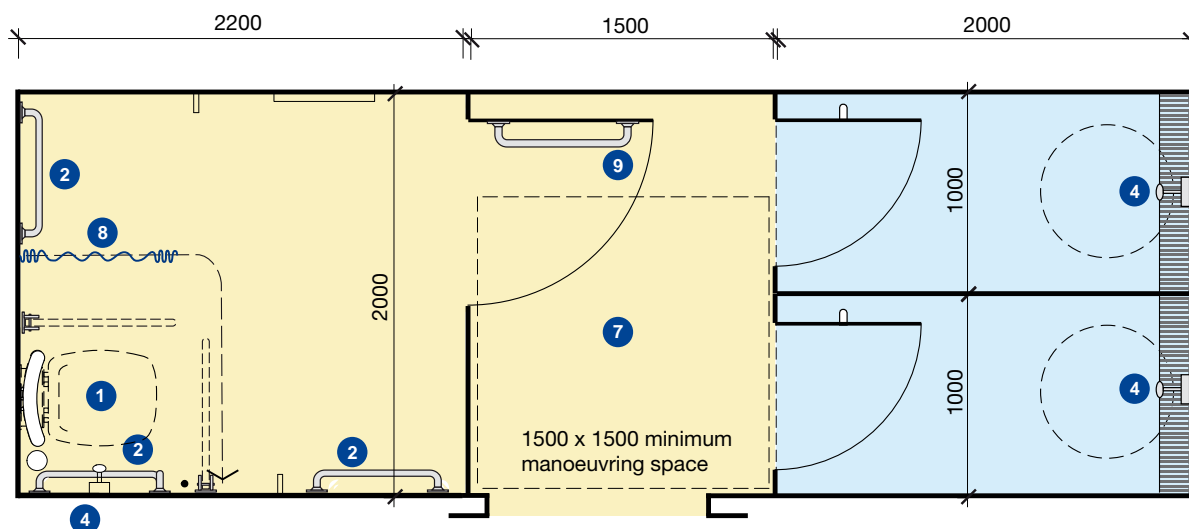

Note: All dimensions are in millimetres

Figure 23 Accessible shower cubicle incorporated into main shower cubicle area

8.0 Toilet Provision

Unisex Accessible Provision

All sports facilities should have at least one clearly signposted unisex accessible WC cubicle on every floor of the facility. Unisex provision allows people of either sex to give assistance, which is not possible when the accessible toilet provision is part of a dedicated male or female area.

The provision of accessible toilet cubicles within dedicated male or female areas is considered to be additional provision and cannot replace unisex provision.

It should be noted that these toilets are used by people with a wide range of disabilities and not just wheelchair users.

- A unisex accessible WC cubicle should be accessible from all areas of the facility including social, refreshment, changing and staff areas.

- Every part of a sports facility, including the pool or field, should be within 40m of a unisex accessible WC.
- The cubicle should be located close to the changing areas unless there are dedicated unisex accessible changing rooms incorporating WC's within the changing areas.
- Where dedicated facilities are provided in the changing rooms a unisex accessible WC cubicle should be located close to the entrance to the main facility so that it can serve visitors and spectators as well as participants and staff.
- The scale and type of the facility will determine the number of accessible toilets. However, unisex accessible toilets should be provided wherever there is toilet accommodation.
- Provide an embossed sign adjacent to the entrance door of all toilets.

Minimum provision	Clubhouses/pavilions (serving only natural turf pitches)	Clubhouses/pavilions generally	Full-size synthetic pitch	Multi-use games area	Fitness equipment room	Four-court sports hall	Six-court sports hall	Nine-court sports hall or larger	Cricket indoor	Gymnastics hall	Tennis indoor	Tennis outdoor	Bowls indoor	Bowls outdoor	Table tennis centre	Athletics indoor	Athletics outdoor	20m swimming pool	25m swimming pool	50m swimming pool
Accessible unisex WC compartment on each floor (can be shared with unisex changing) ¹ - Fig.24	●	●	●	●	●					●		●	●	●	●		●	●		
Dedicated unisex WC compartment (in addition to any provision within unisex changing). Numbers/flow to be determined by the size and layout of the building ¹ - Fig.24		○	○	○		●	●	2	●	○	●	○			○	●	○	●	●	●
Provide at least one cubicle within the general male and female toilets suitable for an ambulant disabled person - Fig.27	○	○	○	○	○	●	●	●	●	○	●	○	●	○	○	●	○	○	●	●
In addition provide an accessible unisex WC compartment located within the 'sports chair' zone to serve people using large sports chairs - Fig.25						○	○	○	○	○	○	○	○	○	○	○	○	○	○	○
In addition provide a Changing Places Facility as Fig.19								●											●	●

Key: ● Required ○ Recommended

¹ Unisex accessible toilets must be located wherever there is general toilet provision

Table 9 Accessible toilet provision – requirements

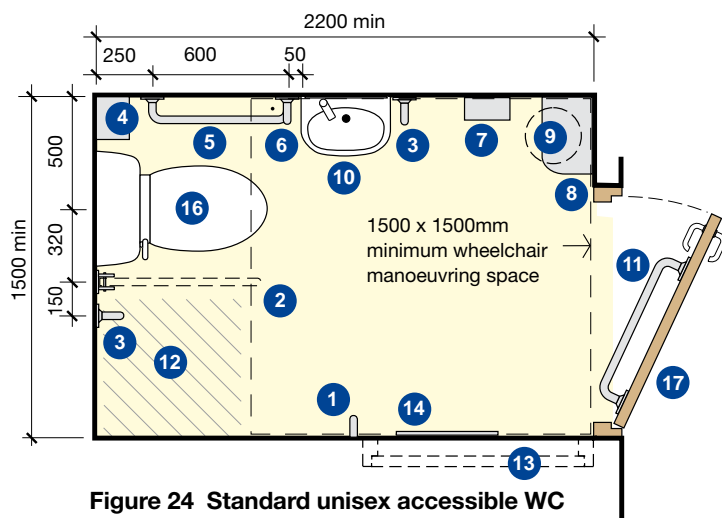

Figure 24 Standard unisex accessible WC (left hand transfer)

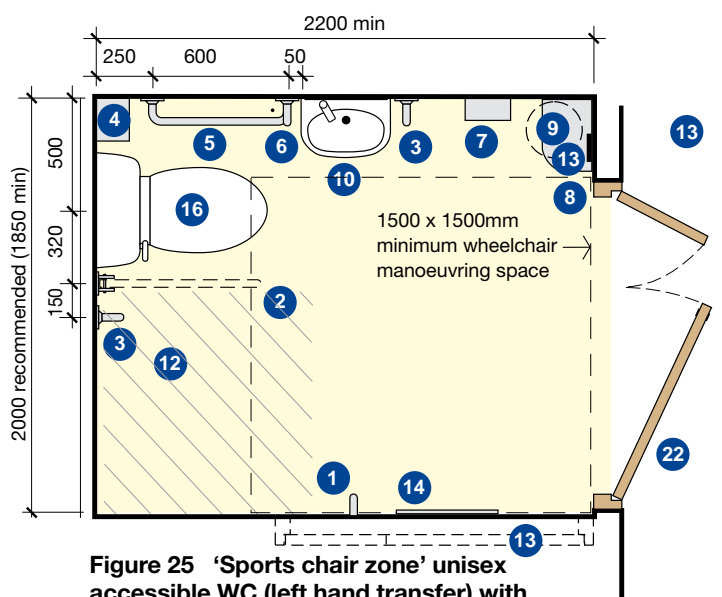

Figure 25 'Sports chair zone' unisex accessible WC (left hand transfer) with power operated door set

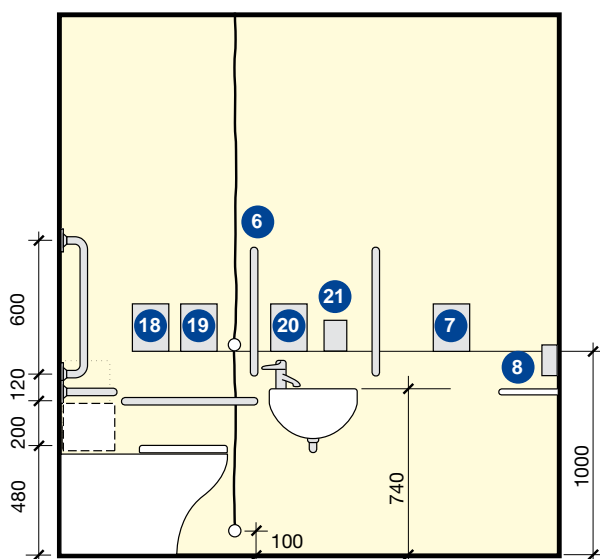

Figure 26 Key vertical dimensions and fittings to accessible WC and changing area

Note: Dimensions to all figures are in millimetres

Key

1. Two clothes hooks set at 1400mm and 1050mm above floor level
2. Drop-down rail (without toilet roll holder)
3. Fixed vertical rail
4. Colostomy changing shelf for ambulant users 950mm above floor level
5. Fixed horizontal grabrail
6. Fixed vertical rail and adjacent alarm pull-cord with two red triangles
7. Automatic hand dryer
8. Low shelf with rounded corner and sanitary dispenser with controls located 1000mm above floor level
9. Disposal bin for miscellaneous items with sanitary dispenser above (750-1000mm above floor level)
10. Hand basin can be recessed in order for a larger basin to be used (as an alternative to a standard small basin) The thermostatic mixer tap to be located on the WC side of the basin.
11. Horizontal door pull to enable door to be closed when entering
12. It is essential to keep the area adjacent to the WC clear to allow side transfer onto the WC
13. Wall mounted access control touch pad set at 1000mm above floor level located clear of door swings
14. Mirror 1500mm high, located 600mm above floor level
15. Colostomy changing shelf for ambulant users 950mm above floor level
16. WC: flush lever to wheelchair transfer side; transferring from a wheelchair to a WC imposes significant forces, therefore all fittings must be robust. Wing nut fixings should not be used to secure the toilet seat.
17. 1026mm door to achieve minimum clearance requirement of 875mm
18. Toilet paper dispenser
19. Alarm reset button
20. Paper towel dispenser
21. Soap dispenser
22. Power operated double door set to achieve minimum clearance requirement of 1200mm for wider sports chairs in a 'sports chair' zone

Design

The layout and dimensions of an accessible toilet are critical to ensure that the cubicle will be properly and safely used. Figures in BS8300 and Approved Document M provide detailed layout and dimensions for a unisex, corner WC.

- The standard layout will allow most users to wash and dry their hands while seated on the WC before transferring back to their chair.
- Where it is necessary to incorporate fittings such as radiators, vending machines, sanitary disposal units and wastepaper bins, these should be recessed or located so that they do not obstruct the defined manoeuvring space / transfer space.
- Ensure that pipe boxing is carefully designed so that it does not restrict movement or create a hazard.
- Where more than one accessible toilet is provided a layout of the opposite hand should be incorporated to give access from both sides.
- The appearance of an accessible toilet is important – it should not appear to be ‘medical’ and should be finished to the same standard of appearance as the rest of the facility, making good use of contrasting to highlight the sanitary fittings and grabrails from their backgrounds.
- Ensure that the door opening is located so that there is a degree of screening from the main circulation areas. This will mean that the WC cannot be seen if the door is ajar when the cubicle is not in use. More importantly, it will prevent a user being seen while their helper is exiting or entering the cubicle.

- Use plastic-coated handrails and grab rails for comfort.
- In larger sports facilities, where there are several unisex WCs one unisex accessible peninsular WC should be provided as detailed in BS 8300.

Religious and cultural considerations

It is important that designers consider carefully the religious and cultural implications of their proposals and consult closely with local disabled users.

A scheme serving certain cultural communities may for example have aspects of toiletry and hygiene that require careful design. Communal shower/changing facilities and urinal troughs could be unacceptable given the requirement for complete visual privacy and there may be a need for ancillary facilities, such as a bidet or other sluice arrangements. Additionally, the orientation of facilities could be important.

General provision

Except in small facilities ie where there is less than four cubicles in a toilet, a cubicle (as illustrated in Fig 56 of BS8300) should be incorporated within each general male and female toilet area for use by the following:

- Older people
- Carers accompanying small children
- People with a need for mobility equipment such as walkers, crutches, higher seat levels.

Within each general male toilet area one of the urinals should be fitted with grab rails.

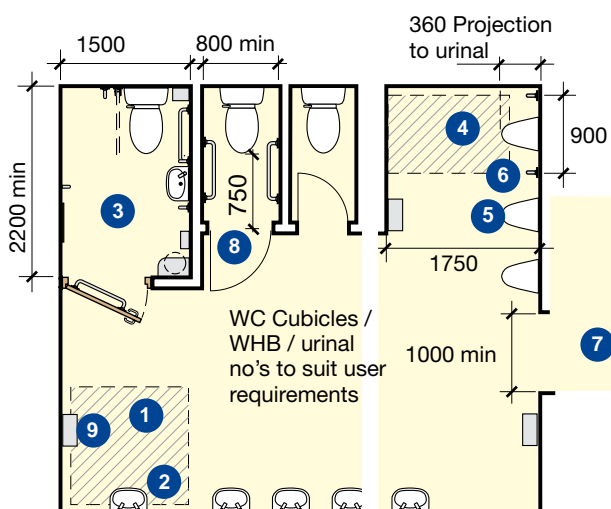

Note: All dimensions are in millimetres

Figure 27 General toilet provision incorporating wheelchair accessible toilet facilities

Key

1. 1500 x 1500mm wheelchair space to hand basin
2. Hand basin set at 720–740mm high to be suitable for wheelchair and ambulant disabled users
3. Accessible WC cubicle
4. 1400 deep by 900mm wide wheelchair space
5. Urinals set at 500mm maximum height, except urinal installation for wheelchair users, which should be set at 400mm max height
6. Vertical grabrails (set at 1100mm centre line height above floor level) for wheelchair users – keep space clear of pipework
7. Suitably designed access lobby giving privacy with ease of access
8. Cubicle for ambulant disabled people
9. Hand dryers set at 1000mm above floor level

9.0 Social Areas

Social areas must give unhindered access to disabled people either independently or with companions. All corridors and doors leading to refreshment/social areas must comply with the minimum space standards for the facility.

Layout

- Gangways in areas between tables and other furniture and fittings should have at least 1.2m clear width.
- Tables and chairs should be placed in a regular layout rather than a random, complex arrangement.

Furniture

- Furniture should be stable but movable to allow maximum access within social areas.
- Consider the use of tables with legs rather than a central pedestal. This will ensure stability if the table is used to support a person rising from their seat. Tables should have a clear under-top height of at least 0.7–0.75m to allow a wheelchair to be drawn in.

Seating

- Seating should be provided wherever people may need to wait.
- Where provided, seating should be stable and easy to rise from.
- Where low-level seating is provided, some seating with a seat height between 0.45m and 0.475m should be provided.
- Seats should not be upholstered in absorbent material.
- They should incorporate fittings with and without armrests.



Appropriate colour schemes and furniture can create an accessible and inviting interior

- Seating should be arranged to allow wheelchair users to sit alongside others without obstructing the general circulation routes.
- Seating should contrast visually with the surrounding surfaces.
- Seating areas should be acoustically 'quiet' to allow easy conversation.

Servery

- Bars and self-service counters should be accessible.
- Provide a section lowered to 0.76m above the floor with a clear space of 0.7–0.75m underneath. However ensure that hot surfaces are kept away from these locations to protect children from accidental access.
- Induction loops should be fitted at counters.
- Control natural light entering the space and design artificial lighting to avoid glare. Avoid specifying large areas of shiny surfaces which can cause reflective glare. Both types of glare can cause disorientation and discomfort to blind and partially sighted people and are not conducive to lip reading.
- Where tray slides are used, they should be continuous to the till.

Vending machines

- Vending machines should have clear display panels and instructions.
- The coin slot should be no higher than 1.2m above floor level.
- There should be adequate manoeuvring space in front of the vending machine for wheelchair users.



Address access issues and integrate solutions into the design to create interesting facilities for everyone

10.0 Communication Systems

Public Telephones

Access to a telephone is particularly important to help disabled people maintain their independence. Except for small pavilions and clubhouses, all sports facilities should have a public telephone that can be used by everyone. This means that they should:

- Be located where there is minimum background noise and be approachable from the front and the side.
- Be fixed at a height which allows access by children and people of short stature and wheelchair users.
- Be fitted with an inductive coupler to assist hearing aid users.
- Have a raised tactile button on the five numeral.
- Have a shelf to enable the use of a portable text phone.
- Be clearly signposted and located so that the phone and user do not create an obstruction or hazard.
- Have an unobstructed space of 1.5 x 1.5m in front of the telephone.

Public address systems

These should be clearly audible and wherever practicable, supplemented by visual information. Details of systems designed to assist people who are deaf or hard of hearing can be obtained through the RNID (see contact addresses).

Text phones

Many people with hearing impairment may use text phones to communicate over the telephone.

- Two-way textual messages can be communicated over the telephone line.
- Large sports facilities should be equipped with a text phone to facilitate telephone bookings and general communication by staff or users with a hearing impairment.

Induction loops

Induction loops can help many hearing aid users to communicate. Sound from a microphone or sound system is converted into an electrical field and fed into a loop producing a magnetic field.

Hearing aids are set to the 'T' position to pick up the broadcast information. Induction loops that comply with BS 7594 and BS EN 60118-4 should be fitted:

- At reception counters.
- In meeting rooms.
- In dance and exercise areas.
- In other areas where aural information is given.

There is a chance that people wearing hearing aids in adjacent rooms may experience 'overlap'. This may be a problem for committee rooms or rooms where confidentiality is important, and in these cases it may be more suitable to use an infrared system.

Infrared systems

Infrared systems work by converting the sound into an infrared light signal and users wear a special headset to pick up the signal. Infrared systems transmit a higher quality of sound to the user than induction loop and infrared can be easily contained within a room. Infrared light is absorbed by sunlight and therefore these systems are not suitable for example within the seating bowl of a stadium. The head sets are expensive and require to be charged, cleaned and stored. Induction loops rely on the users own hearing aid as the receiving equipment.

Controls

- All controls should be clearly visible against the background. This means good lighting and the use of contrasting colours.
- Controls should be located in a consistent and logical manner and should be mounted at a height accessible to everyone. However, where controls may pose a safety risk to children or people with learning disabilities, then protection (e.g. lockable covers) should be provided.
- Wherever possible consider the use of embossed tactile buttons and controls for use by staff and users.

Signs

A large proportion of disabled people have a hearing or visual impairment and it is common to have both. People with either or both of these impairments rely upon clear signage in order to move around and use a facility independently. Good signage can mean that a person with a

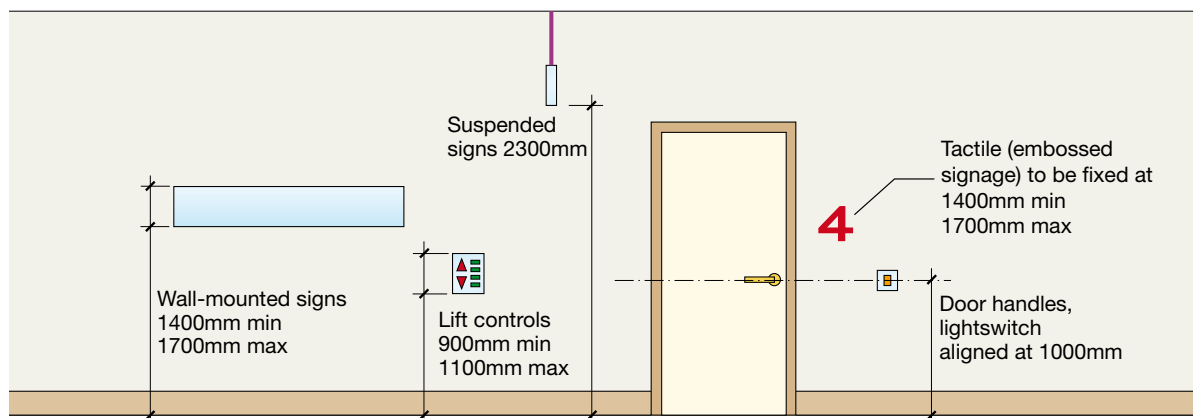

Use colour and tone to ensure the controls are distinguishable from their backgrounds

Figure 28 Signs and controls – consistent positioning is critical

hearing impairment can use a building without having to ask questions, and it can help a person with a visual impairment to navigate more effectively.

- Signs inform and provide reassurance.
- Signs may give people one of their first impressions of a facility and contribute significantly to the character and aesthetic of the building.

The following sets out clear requirements for a good signage scheme and is intended to provide the basic information around which an imaginative and effective scheme can be created. For detailed information on signage refer to the Sign Design Guide: a guide to inclusive signage published by the JMU Access Partnership.

www.signdesignsociety.co.uk/



Clear simple signs with strong contrast between lettering and background, and between the sign and the adjacent space are essential.

General requirements

- To avoid confusion the number of signs should be kept to a minimum in order to create an easily understood chain of information.
- The location of signs is critical to allow visually impaired people to find the sign and then get as close as possible to the sign to see it or read it by touch.
- Signage should be consistent in location and style throughout the building.
- Signs should be obvious, identifiable, clear and legible. Use of colour and contrast is important in respect of readability.
- Wherever possible, signs should incorporate words and symbols. The symbols should be standard symbols in common use that are easy to understand.
- Where practical, signs should be located on walls at average eye level and have embossed letters, raised pictograms and direction arrows.
- Signs should be suitably illuminated and located so they are free from glare.
- The use of suspended signs should be avoided wherever possible. Where they are unavoidable the size of the text and sign should be adequate to allow it to be read from a reasonable viewing distance.
- Signs should not have sharp edges and should not cause an obstruction.
- Wall-mounted information boards should be provided at lift landings, floor landings on staircases and at other major decision points on main circulation routes.

- Signs to rooms, with the exception of toilets, should be placed on the wall of the leading edge side of the door so that the sign is visible even when the door is open.
- Avoid signs on 'A' boards or other portable systems that could obstruct access and cause a hazard to visually impaired people.

Design

- The sign layout should be clear and logical.
- Text should always be 'left justified' except where directional arrows are incorporated. Where arrows are used the text should be justified on the side of the direction indicated. For example, on right-pointing arrows text should be justified on the right.
- Where text and arrows indicate 'straight ahead' they should be placed at the top of the sign with arrows on both sides of the text.
- Text signs should be a mixture of upper and lower case letters – this is because words are recognised by shape rather than by individual letters.

The font style should be Helvetica-type sans serif or a similar uncomplicated style. Serif-type fonts can be used but only where detailed guidance has been sought.

- The spacing between letters and words should be increased by 20–30% to suit the selected letter form. Inter-word spacing should be increased by about 25%.
- Line spacing should be increased by 15–20%.
- The size of text on a sign should be consistent.
- For long distance reading a minimum character size of 150mm is recommended.
- For medium range reading (internal directions etc) a character size of 50–100mm is recommended.
- For close-up reading (wall mounted information etc) a minimum character size of 15–25mm is recommended.



- Tactile characters should be embossed or raised to an approximate thickness of 1–1.5mm and should not be engraved. Reading an embossed sign in the vertical plane is not comfortable; inclining the face of the sign at 45–60 degrees from the horizontal provides a more natural position for the hand.
- All signs should be in colours that contrast with the background, 70% being the optimum contrast.
- Similarly, the sign characters should contrast with the sign background.
- Sign borders will enable a sign to be located on both light and dark backgrounds.
- Signs should be non-reflective with a gloss factor no greater than 50%.
- Avoid long lists of names on direction signs. If possible group the names in sets of no more than three.

Braille

Braille comprises a sequence of fine dots, proud of the surface, read by passing the fingers across them. It is the method of reading used by some people with a visual impairment or total blindness.

- If possible, Braille should be used wherever embossed characters are used.
- Braille should be English Standard Braille.
- Grade 1 Braille should be used for single words and short descriptions.
- Grade 2 Braille should be used where it is necessary to reduce the length of multi-word signs.
- Braille signs should incorporate a marker such as a notch at the left hand side to help locate the Braille message.

11.0 Finishes

The correct selection of finishes is very important, particularly to assist people with a disability. Unsuitable finishes can make the building difficult to use and can lead to confusion and possibly danger.

Acoustic requirements

Hard and reflective surfaces

Spaces enclosed exclusively with hard surfaces should be avoided. They are likely to be noisy and reverberant spaces that are confusing for people with sensory impairments to use.

- All rooms and spaces should have some soft, sound-absorbent surfaces to provide a suitably quiet acoustic environment.
- Where possible, separate quiet and noisy areas by buffer zones.
- High levels of background noise can make it difficult for people with a hearing impairment to communicate with facility staff or other customers / colleagues.

Ceilings

Ceilings usually provide the best opportunity for the provision of acoustic absorbency.

Visual requirements

Visual contrast

Colour should be carefully considered to enhance the facility's aesthetic qualities and to optimise the practical use of the building, particularly the ability of people who are visually impaired to move around without difficulty.

Of people registered blind or partially sighted, 96% have some degree of vision that can be significantly enhanced by good use of colour, luminance and textured surfaces.

Guidance on the use of colour and contrast is available in BS8300 Annex B and from the Design Guide based on the Project Rainbow research published by ICI Plc.

www.icipaints.co.uk/support/specifications/colour/accessibility/regulations.jsp

When moving through a building, a visually impaired person tries to find contrast between large areas of colour, such as the junction between a wall and ceiling. This technique gives them clues to where they are and the size of the space they are in.



Research has shown that colour and tonal differentiation between ceilings, walls, doors and floors makes a significant difference to visually impaired people as they navigate through a building. Tonal contrast is as important as colour contrast. Some sight conditions can lead to confusion between similar colours and tones.

- Colour schemes should not be monotonous or bland.
- Ceiling colours should be sufficiently different from wall colours.
- Wall colours should be sufficiently different from ceiling and floor colours.
- Door colours should be sufficiently different from wall colours.
- The leading edge of doors should contrast with the main body of the door.
- Floor and stair colours should be sufficiently different from adjoining wall colours.
- All fixtures and fittings must contrast visually with the adjacent surface on which they are located.

The contrast should be incorporated into the overall design of the colour scheme rather than imposed upon it.

- Avoid using extreme contrasts in colour in irregular, busy, geometric or striped patterns.
- The colour used for a trim feature, such as a skirting or architrave, should not be an intermediate of the colours of two adjoining critical surfaces. This colour should maintain or improve the impact of the different colours used.
- Paint manufacturers can supply tables that define the minimum colour contrast thresholds required to assist visually impaired people, and so help to create an interior that is acceptable to everyone.

Surface

- Walls and floors with a glossy appearance confuse visually impaired people.
- Glossy surfaces should be avoided. Glare and reflection make it difficult for people to lip-read.
- Use matt or mid-sheen finishes to obtain the maximum benefit from colour differentiation.

Tactile requirements

Variation in surface texture provides important information, particularly to visually impaired people. It can:

- Warn of hazards.
- Give information that helps identify location.

Walls

- Avoid large repeating patterns with bold contrasting colours that can distract people when they are lip-reading – at a reception counter or in a meeting room, for example.
- Tiling, like all wall surface colour, should be used to provide a pleasing contrast to fittings, rails etc. For example, the ‘all white’ appearance of sanitary fittings and white wall tiling should be avoided.
- Consider carefully the texture of walls as some users depend upon contact to gain support and orientation.

Floors

The look, texture and acoustic quality of flooring can affect how a building is used. It can give directions, suggest the type of activity space and help to create the appropriate atmosphere. All flooring should be:

- Firmly fixed to ensure safety and ease of movement by wheelchair users and people with ambulant disabilities.
- Free of tripping hazards, particularly at the junction between materials.



Contrasting colours facilitate court markings and contribute to a bright environment

- Able to withstand marks left by wheelchairs and other mobility aids so that users are not restricted by over-protective management regimes.
- Slip-resistant.
- Selected to avoid a highly polished surface as they are slippery and may look wet, which may affect the way a person may move across them.
- Non-glossy. Glossy floors reflect overhead lights, causing confusion and discomfort for some visually impaired people.
- Shallow dense non-directional pile where carpet is used.

In areas that may become wet, such as the building entrance, changing and shower areas or poolside, it is vitally important to specify slip resistant surfaces or safety flooring.

- In wet areas the floor should be kept as dry as possible. Adequate heating is essential (underfloor heating can be particularly beneficial) and the floors should be laid to ensure adequate drainage, with falls at a preferred gradient of between 1 : 35 and 1 : 50.

Tactile floors

- For the visually impaired person, changes in the texture of the floor surface can warn of potential hazards and give directional information.



- It is critical to use recognised tactile floor patterns in the appropriate location as incorrect use will cause confusion and could be dangerous.
- Wherever possible the design should exclude protruding features that project into circulation routes, since these can be a hazard to blind and partially sighted people. In the event that this is unavoidable, a suitable barrier should be used to prevent access to the affected area.

Glass walls and screens

Glass walls and screens need to be designed to meet the following:

- Should conform to BS 6262.
- Should be highlighted with coloured warnings (not treated glass) at least 0.15m square or unbroken lines at least 50mm high that contrast with the surface and are located between 0.85m and 1.0m to be visible to wheelchair users, and between 1.4m and 1.6m to be at eye level for ambulant people.
- Care should be taken to avoid reflections in the glass as this can create confusion for some people with limited sight.
- Exposed edges of a glazed screen should be highlighted with a strip of contrasting colour and luminance to its surroundings.

12.0 Services

All services must be carefully located to avoid creating hazards or obstacles to people moving through the facility.

- There should be no exposed angles.
- Carefully consider the effects of background noise or magnetic fields from service equipment that may affect people's ability to communicate.

Electrical services

In large sports facilities the main power supply cable to the building may induce interference in hearing aids and should be routed away from public and staff areas or be suitably shielded.

Heating

- Locate the pipework and any heat sources such as radiators to avoid hazards to users.
- Where radiators are used, they should be of the low surface temperature type or be covered with a suitable low temperature casing.
- Uncomfortable variations in temperature should be avoided.
- Ensure all areas are well heated.
- Locate and detail windows and exit doors to avoid the creation of draughts and cold areas.
- Heating, ventilation and air-conditioning systems should be quiet.

Lighting

Artificial lighting systems must create a confusion-free environment that avoids excessive reflection, glare, deep shadows and wide variations in lighting levels. The lighting design should aim to achieve this by controlling the location, quantity and quality of both natural and artificial light.

- Careful lighting design can accentuate changes in texture and colour and provide additional information to visually impaired people.
- Changes in lighting levels should be gradual throughout the facility.
- Avoid locating reception desks in front of large areas of glazing where high light levels could put a receptionist's face in shadow and make lip-reading difficult.
- Daylight and particularly direct sunlight should be carefully controlled to reduce glare. This may be a particular problem during winter months when sun angles are low.

- Avoid shadows that could conceal potential hazards. This can be achieved by ensuring there are enough light fittings to provide an adequate coverage of light.
- Where possible, minimise the use of spotlights in isolation, since this type of light fitting tends to create pools of light and shadow.
- Avoid the use of uplighters set in floors or paved areas where people are likely to walk, since anyone walking over these fittings is likely to experience painful glare.
- Downlighters should be carefully located so that they do not create shadows across people's faces making lip-reading difficult – at the reception desk for example.
- Staircases should be well illuminated – minimum 100 lux at tread level.
- Lighting should meet CIBSE standards for the type of space, and relatively even, giving good differentiation of surfaces and levels without glare.
- Indirect rather than direct lighting is the most comfortable form of light.
- Light sensors can be used to control light levels by the introduction or reduction of artificial light.
- Particular care should be taken with the design of lighting insert systems in areas with shiny surfaces in order to avoid reflections and glare.
- Glazing at the end of corridors should be avoided; side lighting is preferable.
- Some fluorescent fittings can cause interference in hearing aids. Minimise this by careful placement of light fittings and by using high frequency fittings.



13.0 Management Issues

The design measures included in this guidance will help make facilities more accessible to disabled people and more user-friendly for everyone. However, the sports facility must be managed effectively in order to meet the needs of the widest range of disabled people.

Research has shown that the way a sports facility is managed has a significant impact on how accessible it is to disabled people, and how likely they are to return.

For example, an accessible toilet that is used as a store is useless, as is the installation of an induction loop at the reception desk if members of staff have not been trained to use it.

Similarly, the carefully designed lobby into the changing room will be rendered inaccessible by the careless positioning of obstacles such as a large litterbin.

Examples of issues to be addressed:

- Pathways, ramps, steps, corridors, lobbies should not be obstructed.
- All walking surfaces, particularly ramps and steps, should be regularly maintained and kept clean to ensure slip-resistant surfaces. During winter weather, additional steps should be taken to avoid ice build up on walking surfaces.
- Ensure that doors are maintained to open and close with the minimum possible force.
- Ensure that slip-resistant floors are not made dangerous by use of cleaning fluid or polish.
- Signs and maps, both audio and visual, should be checked regularly to make sure routes are clearly indicated, especially escape routes. The accidental removal or obliteration of one or two signs can create great confusion, as can the addition of temporary signs by staff who have not considered the clarity of the whole route.
- Lifts and hoists should be checked and maintained regularly, for example to ensure that the lift stops exactly level at each floor.
- Induction loops and other electrical aids should be regularly checked – deterioration and failure are not always obvious.
- Ensure that the dedicated accessible car parking bays are used only by those for whom they are intended.
- Ensure that light fittings are maintained and delivering optimum light levels at all times.
- Ensure that flooring does not become worn or loose creating a trip hazard.
- When carrying out maintenance and redecoration ensure that existing accessible provision is not compromised, for example by using an inappropriate fitting or an unsuitable colour scheme.



- The facility should have a policy on assistance dogs.
- The facility should have an emergency evacuation strategy which includes the needs of disabled people.
- Waste bins placed in wheelchair transfer spaces.
- Alarm pull cords tied up in toilet and changing rooms.
- Shower heads being left too high in accessible changing rooms.

All buildings should have a management / maintenance manual addressing the above issues, with explanations to emphasise the importance of good management in maintaining quality access to the facility.

All staff should have disability equality training ensuring the delivery of good customer service. This training needs to be continually updated and refreshed for existing as well as new staff.

Provide information in various formats so that visually impaired people can use it. This does not necessarily mean that such materials should be immediately to hand, but that mechanisms are in place for providing different formats and getting these to customers quickly.

It should be possible to provide information in audio, Braille, large print or web-based formats.

The information should include:

- Opening times/booking conditions
- Travel details such as bus routes, train stations and community transport. Note that many people with disabilities rely on public transport.

At large sites:

- Consider separating the tasks of answering the telephone and staffing the main reception so that callers' queries can be answered in a quiet environment at busy times.
- Adopt a strategy for directing text phone calls to a central point where the most frequently asked questions can be dealt with on behalf of a number of different sites.
- Establish and maintain emergency procedures for people with various disabilities who are likely to use the facility.

14.0 Spectator/Viewing Provision

Wherever possible, spectator seating, media seating and executive boxes should be designed to be accessible to everyone.

When designing spectator/viewing provision, the following should be considered:

- At very large venues where crowd control and safety are particularly important factors, it is acceptable to provide separately designated points of access into spectator areas for disabled people. These entrances should provide a clear opening of 1.0m.
- A minimum clear width of 0.65m must be provided between rows of seats.
- Without blocking circulation routes, consider making space for guide or assistance dogs to sit next to their owners.
- Provide at least six designated wheelchair spaces, or 1% of the spectator capacity, whichever is the greater.
- Wheelchair user spaces should be located within the seating area so that users can sit next to seated companions.





- Wheelchair user spaces must be located so that users do not feel cut off from the rest of the crowd.
- In order to provide for greater demand during special events, provision should be made for increasing the number of wheelchair user spaces by the provision of removable seats.
- Sight lines must enable all wheelchair users to have a clear view of the action at least up to the edge of the area of play and unobstructed by people in front or by structural features.
- The seating arrangements should ensure that good sight lines are achieved even if the crowd stands up at moments of excitement.
- Wheelchair spaces should be a minimum 0.9 x 1.4m each.
- Handrails should be provided to stepped access routes to assist ambulant disabled people, and if practicable, central handrails are the preferred option.
- Barriers, balustrades, handrails and columns must not obstruct sight lines.
- Where spectator provision includes a public address system, this must be supplemented with appropriate hearing aids, such as induction loops and visual text displays for people with hearing impairment.
- Consider providing match commentaries to assist people with visual impairment. This can be achieved by placing headphone sockets at specific locations or by using an infrared or FM communications system.
- The design of informal viewing areas in sports facilities should consider the needs of all users. For example viewing from the reception area, balcony or a circulation space should have areas of suitable height to allow wheelchair users or children adequate sight lines⁷.
- The design of bleacher seating and rebound screens should also be considered when temporary spectator seating is created. For example a raised dais and ramp section might be integrated into the lower sections of a retractable bleacher seating unit.

⁷ It should be noted that such casual viewing into sport spaces should be capable of being screened off to give privacy to users if required.

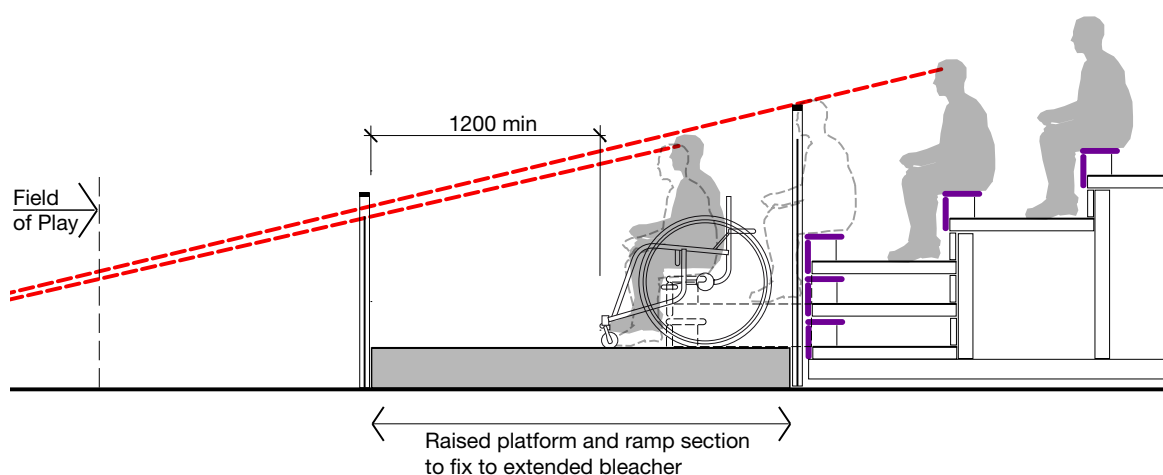

Fig 29 Section indicating raised platform to bleacher seating for elevated wheelchair viewing

15.0 Swimming Pools

Detailed guidance on the design of swimming pools can be found in separate Sport England Design Guidance.

See 'Swimming Pools' design guidance note download available from the Sport England website.

The following section emphasizes the key considerations to ensure that access is provided in all swimming pool facilities.

Swimming is an important activity for many disabled people at both competition level and purely for recreation. Water supports people's bodies freeing those with mobility impairments from the need to use mobility aids, such as crutches and wheelchairs. Most of the guidance in the earlier sections of this document is applicable to swimming pools. However, swimming pools do pose particular problems for the designer and manager and these are often overlooked.

- All pools must be designed to allow full integration of disabled swimmers in all activities. Management should also provide integrated swimming sessions with additional support, as well as 'specialist' sessions for those who require specialised help or prefer segregated activities.
- The route through a swimming pool complex should be the same for a disabled swimmer as a non-disabled swimmer.
- Bare feet on wet floor surfaces make movement more difficult and more dangerous for people with mobility impairments.
- Disabled people can often be self-conscious in a pool setting because they may be without their aids, are physically exposed, and may require assistance to enter the pool.
- Disabled swimmers are often most vulnerable when making their way to the pool or back to the changing room. Once in the water they can be relatively safe.
- People who need glasses to correct a visual impairment or hearing aids to improve their hearing are likely to be at a considerable disadvantage when swimming.
- The pool environment can be visually and acoustically confusing if not properly controlled.

Changing areas

Changing areas are often inadequate and poorly designed – particularly for disabled users. It is very important that all changing areas are of a good standard and provide a pleasant environment. The design will affect users' perception of the facility and, if done badly, can restrict or stop people using part or all of the facility. Modern pools have a mixture of single and mixed-sex changing provision comprising:

- Village changing.
- Large, single sex open-plan changing areas with benches.
- Enclosed rooms for families or small groups of users.

All of these changing room configurations, with the addition of some unisex accessible changing provision, can be designed and detailed to provide integrated and accessible changing facilities which address the needs of a variety of different disabled swimmers.

To encourage maximum use of the facility, ensure that the needs of disabled people are considered at the very early stages of design.

General considerations

The following should be provided as part of the design:

- High quality, accessible showers and WC's in close proximity to the changing areas.
- Benches at least 0.45m deep (0.5m preferred) from front to back.
- In order to provide space when assisting an adult there should be a 1.8m length of bench 0.6m deep.
- Mats to place over benches for people with sensitive skin and for those who are susceptible to injury.
- Lockers within reach of children and disabled swimmers, i.e. 0.4–1.3m high.
- At least four 'full-height' lockers typically 1.8m high by say 0.4m wide for storing mobility aids, for example crutches, callipers and artificial limbs.
- Adequate space in all changing areas/rooms for wheelchair users and others with mobility impairments to transfer to self-propelling skeleton waterproof chairs.

- Minimum of two self-propelling skeleton waterproof chairs, not only for wheelchair users but for ambulant disabled people who become less mobile without their aids.
- Safe and secure storage for wheelchairs.

Changing villages

Well designed village changing will meet the requirements of many disabled swimmers. It will provide privacy and at the same time allow users to be accompanied by someone of either sex if required. Provide at least four large cubicles suitable for use by disabled swimmers.

Open-plan changing

A number of large cubicles and/or changing rooms are required to give additional privacy and accommodate the support rails that are required by some disabled swimmers.

Changing rooms

These are often dedicated family or group rooms. However, they can be used to great advantage by individual disabled swimmers or small groups of disabled swimmers who require more privacy or space when changing.

Family changing cubicles

Where space is available family changing cubicles should be provided. These should have a changing bench 0.6m deep by 2.0m wide and a small play pen to hold a toddler safely when parents are changing or dealing with others.

Ideally, to provide room within the cubicle for a wheelchair user and to accommodate the support rails that are required by some disabled swimmers, the cubicle should be a minimum of 2.0 x 2.0m and preferably 2.0 x 2.6m. See figure 20 on page 43 and Table 10 below.

Facility type	Minimum number of Family / Disabled Cubicles
Small Community Pool (20m)	2
Community/Competition Pool (25m x 6 lane) + Learner Pool (13m)	4
Competition Pool (25m x >6 lane) + Learner/Warm Up Pool (20m)	6
Competition Pool (50m) + Learner/Warm Up Pool (20m)	6-8

Table 10 Family / Disabled Cubicles - requirements

	20m swimming pool	25m swimming pool	50m swimming pool	Learner pool	Diving tank
Self-propelling waterproof chairs (min)	1	2	3	*	*
Poolside hoist (single position)	●	●			○
Poolside hoist (multiple position)	○	○	●	●	●
Submersible pool surround lift	○	○	○	○	○
Mobile hoist	○	○	○	○	○
Portable easy going steps	○	●	●	●	
Minimum number of full-height lockers	4	4	8	*	*
Minimum number of wheelchair accessible lockers	4	4	8	*	*
Changing mats	●	●	●	*	*
Key: ● Required ○ Recommended * As main pool provision					

Table 11 Pool equipment – requirements

Unisex changing provision

To enable helpers of either sex to assist disabled swimmers, all pools should have at least one fully equipped unisex accessible changing room (See Table 8). Fifty-metre pools should be provided with at least two rooms. The changing area should be self-contained and include:

- Facilities for hanging clothes and towels and access to suitable lockers for clothes storage
- Hair and body drying facilities (consider wall-mounted dryers with flexible outlets)
- Full-length mirror
- Shelf for personal items
- Shower
- WC
- Appropriate support rails
- Emergency pull-cord with two red triangles allowing activation by someone on the floor
- Visual and audible fire alarm.

Changing Places Facility

For swimming pools likely to be used by severely disabled swimmers who require assistance to change, large changing cubicles should be provided (See Table 8).

In addition to the equipment listed in section 10, the compartment should have:

- A ceiling hoist
- A WC
- A variable height changing bench.

Showers

- All showers should be fully accessible with some semi-enclosed cubicles of appropriate size for use by people who use a shower chair or transferring onto a fold-down seat from a wheelchair.
- Avoid excessive gradients, particularly in more than one direction.

Within each shower area some showers should be fitted with:

- Robust, proprietary drop-down seats that are easy to operate, easily cleaned and maintained, and fold away when not in use.
- Horizontal and vertical grab rails.
- Safe places for soap and shampoo.
- Thermostatic mixing valves with an anti-scald setting (maximum temperature 41° C) that are easy to manipulate with a closed fist by people with a weak grip.
- Separate levers on the controls for temperature and flow adjustment.
- Control valve should be set no higher than 1.2m above floor level.
- Slide bar with a flexible hose and an adjustable spray head. The fittings should be tamper proof to minimise the risk of theft.
- In some locations it may not be possible to use a flexible hose; in which case a two level shower head system should be used.
- A shower wheel chair should be provided as it has some advantages over a permanent seat:
 - Equipped with sides, giving extra support.
 - The user can vary the orientation.

There must be a clear space of at least 1.5 x 1.5m outside shower areas to allow a wheelchair to approach.

Route to the pool

The design of the route to a pool requires care and attention to detail. En route to the pool disabled people are often in an unfamiliar environment without the benefit of their normal mobility aids. The route should:

- Not be confusing or lead directly through a shower area.
- Be free of hazards, particularly standing water and obstacles.
- Have handrails provided between the changing rooms and the poolside to assist ambulant disabled people and those with a visual impairment.
- Provide tactile information at critical points on circulation routes.

Pool design

In the majority of modern pools, the water is level with the pool surround. This arrangement makes entering and leaving the water easier as less upper body effort is required and fewer steps are needed between the edge of the pool surround and pool. The disadvantage is that there is less clear definition between the surround and the pool, therefore clear demarcation of the pool edge is vital.

- Design and detailing of the pool edge must warn swimmers that they are approaching the pool. This is achieved by using colour and tactile information.
- Minimum water depth to provide sufficient buoyancy for adult disabled swimmers is 1.2m. Anything less will lead to people scraping their limbs along the pool bottom. Additionally, shallow depths of water make it difficult for people whose balance is poor to stand upright.
- Learner pools should, however, be accessible to disabled children and other groups who may prefer a shallower depth of water.

Movable floors

Movable floors can be particularly useful in swimming pools as they provide the deeper water necessary for adult swimmers with a lower limb disability whilst allowing flexibility to cater for all swimmers.

Pool surround benching

Benches against the wall on the pool perimeter – especially if they are heated – can be of great benefit to some disabled swimmers. They provide a secure place to rest before entering or after leaving the pool.

Access to the water

Whatever the type and scale of pool, there should be a variety of means of access to the water in order to accommodate all users (see Table 10). It is very important that the design team and the pool management team give careful consideration to this at an early design stage. The various options include:

- Pool access ladder
- Ramped entry
- Steps (built-in and portable)
- Portable slide or chute
- Submersible platform lift
- Hoist.

Pool access ladder

- The ladder should be recessed into the pool tank walls, with treads not less than 0.18m deep from front to back.
- Feet can easily slip down between the treads and the wall so gaps between the back edge of the treads and the face of the poolside should be minimal.



- The treads should be slip-resistant
- There should be no sharp edges
- The ladder should be fitted with continuous handrails on both sides.

Ramped entry

A fully integrated ramp and steps should meet the needs of a wide range of disabled swimmers. This arrangement can be used and enjoyed by all swimmers, especially if it is incorporated into the pool design with imagination. However, a common misconception is that a shelving ‘beach’, often incorporated in leisure pools, is the best solution. This arrangement means that the swimmer has to wade into the pool for a considerable distance without the support of the water. This means that some users will require assistance, for others a handrail would give the necessary support, however, it may not be possible to provide a handrail.



- The Amateur Swimming Association and the Health & Safety Executive recommend that the gradient of a ramp or sloping pool floor be no steeper than 1 in 15.
- Where a ramp or beach has been incorporated into the pool design, 'safe steps' giving access to the full depth of the pool should also be considered.

Steps

As a minimum requirement, in addition to the provision of vertical step ladders, every pool should be provided with a flight of fixed steps that comply with the following criteria:

- Be fitted with handrails that have good grip and contrast on both sides.
- Have handrails with an adequate extension at the top and bottom of the steps.
- Have maximum risers of 0.14m.
- Have minimum going of 0.3m.

- Be fitted with a guardrail where they are recessed into the pool tank.
- Be located at the shallow end.

Lightweight portable step units are available for pools where a built-in flight of steps cannot be incorporated.

- Ensure there is adequate storage provision immediately adjacent to the pool.
- The portable steps should be secured by sockets set flush into the pool surround.
- The goings should be slip resistant and have no sharp edges; any void underneath should be protected to prevent swimmers from entering.

Portable slides and chutes

- These should be lightweight and easy to move.
- Ensure there is adequate storage provision immediately adjacent to the pool.



Todmorden Sports Centre – built-in steps incorporated into the pool surround



Submersible platform lift at Craven Pool, Skipton

Submersible Platform Lifts

Submersible platform lifts provide a flexible and more dignified means of entering a swimming pool for a person unable to walk or having limited mobility. The platform is similar to a moveable pool floor providing a lift set into the pool surround. It enables a wheelchair user to enter and leave a pool with the minimum of assistance.

Hoists

Mechanical assistance should be available to help disabled swimmers into the pool. Some swimmers prefer to be assisted into and out of the water by helpers rather than risk embarrassment by using a slow-moving aid such as a hoist. Hoists are potentially a serious risk to any untrained helper and therefore should only be operated by members of staff trained in their use. When not in use they should be secured against unauthorised use.

Hoists are available in a range of styles. The design and management implications should be considered at a very early stage in the development of the project.

Hoists can be:

- Permanently fixed to the floor in one place.
- Mounted to the floor with a socket and be movable to multiple locations – particularly useful where there is more than a single pool or the pool can be divided by booms into separate pools.

- Overhead electric. Great care should be taken on the selection of a suitable hoist. It should be IP56 rated with any controls operated by low voltage to avoid risk of shock to operators.
- Overhead non-electric.
- Mobile. Care should be taken with selection to ensure that the wheelbase will be stable and not overturn when loaded. Maximum operating weights need to be understood. All wheels should be locked during operation.

The hoist should be discussed with pool users and management. The selected hoist should be fitted with a chair that can be used as a wheelchair to avoid double handling at the poolside. Hoists are also available with additional fittings such as slings and stretcher attachments and the need for these should be agreed with the pool management.

- Hoists should be available to provide access into the learner pool and the main pool at various depths and into a Jacuzzi or spa pool.
- Hoists must be stored safely and conveniently for use at any time.

Equipment and Environment

Transport to the pool

- A minimum of two skeleton-type waterproof wheelchairs should be provided as standard equipment. Storage space should be safe, convenient and easy to access.
- The chairs should be suitable for pre- and post-swim showering.
- Some chairs can be used as toilet chairs.
- Where larger Unisex changing cubicles are provided, they should be equipped with a commode type of shower wheelchair.

Mats

- Adequate storage should be provided for mats and other minor aids to assist disabled swimmers to get changed or enter the pool.

Other Facilities

- If a sauna, spa pool or Jacuzzi is included in the pool complex it should be designed to accommodate disabled users.
- Showers associated with these facilities should be located close by.

Surfaces

Floor finishes must be reliably slip resistant and this usually also results in them being more abrasive. Some disabled swimmers are particularly susceptible to skin damage, especially after being in the pool for a long time. It may be necessary for them to use slippers or a wheelchair over more abrasive flooring.

- The floor finish should be as easy to clean as possible and be regularly maintained with appropriate cleaning agents to remove surface pollutants in order that slip-resistance can be maintained.
- Wall surfaces should be free from projections and sharp corners and be non-abrasive, particularly where bare skin may be present.

Thermal Comfort

Some disabled people are particularly susceptible to the cold in a pool environment because they may have poor circulation and also because the

process of drying and changing can also take much longer. It is important that these factors are considered at design stage.

Consider the following:

- Avoid uncomfortable variations in temperature.
- Windows and doors should be detailed and located to avoid the creation of draughts and cold areas.
- Ventilation supply grilles should not create draughty conditions – even warm air can feel cold to a wet body.

If increased water and air temperatures are required for specific sessions with disabled swimmers, this should be taken into account at an early stage in the design process as it will have a significant effect on the design of the building's fabric and services.

The following are recommended water temperatures.

- Competitive swimming 27°C
- Recreational, adult teaching 28°C
- Children teaching, leisure 29°C
- Babies, disabled people 30°C

However, there are some severely disabled people for whom a higher temperature is required. This could be over 33°C. Where facilities are available, consideration should be given to providing sessions for people requiring the higher temperatures.



16.0 Sport-Specific Requirements

Boccia

Boccia is played indoors by throwing, kicking or using an assisting device to propel leather balls as close as possible to a small white ball that serves as a jack. Players may compete individually or as a team.

- A smooth, flat surface, such as a typical sports hall floor is required to a size of 12.5 x 6.0m.
- Good lighting is required.
- The space should not be located next to a noisy activity. Ideally a microphone should be available for use by the tutor.
- The court markings are normally temporary tape markings. Ideally, in special schools, the court markings should be permanent to reduce the set up time.
- Men and women compete together in all events.

Canoeing

This section should be read in conjunction with the section on sailing where generic issues of access to water sports facilities are covered. The specific requirements for canoeing are:

- Docking bays that give access from both sides of the canoe. These can be incorporated into the design of the landing stage.
- Docking bays should incorporate hoists and frames to assist people to get in and out of a canoe.
- The seat or sling used with the hoist should be comfortable – often the canoeist will remain in the sling while canoeing. Consider providing more than one sling or seat.
- The hoist should have enough reach to extend out over the craft from the landing stage.
- Transfer or sliding boards should be provided and adequate provision made for their secure and convenient storage.

Fitness Suite

All facilities providing services to the public need to be accessible to a wide range of disabled people. Information on aspects of disabled usage is contained within sections of this document. Reference should also be made to all existing



legislation and standards ⁸.

The 'Inclusive Fitness Initiative' ⁹ (IFI) is a valuable resource for information on accessibility, inclusive equipment (that can be used by both disabled and non-disabled people alike), staff training and inclusive marketing strategies.

The initiative can award the 'Inclusive Fitness Mark', which is a quality mark accreditation scheme based on the following;

- Facility Accessibility
- Fitness Equipment Specification
- Staff Training
- Marketing
- Policies and Procedures

⁸ See BS8300:2009 'Design of buildings and their approaches to meet the needs of disabled people – Code of Practice', Building Regulations - Approved Document M: 2004

⁹ See <http://www.inclusivefitness.org>

Sport England and the IFI has been working in partnership with a number of fitness equipment manufacturers for more than five years to ensure that the equipment available on the market is as inclusive as current technology and development will permit.

The lack of availability of accessible fitness equipment can no longer be used as an excuse for 'exclusive' fitness facilities. Furthermore it has been shown that if planned properly, the provision of inclusive fitness equipment does not lead to the need for additional investment or additional space. It simply ensures that your fitness gym is functional for more users than ever before.

The IFI has worked alongside the fitness industry to create an accredited list of fitness equipment. In the UK this accredited equipment list is the definitive guide to inclusive fitness equipment available. Accessible exercise equipment meeting the IFI's requirements has been given the IFI mark.

All fitness facilities in England should aim for full accessibility and IFI Mark accreditation increases the size of the market able to be targeted by a fitness suite. It should be the goal for all new and refurbished centres in the UK, regardless of sector, wishing to become more inclusive. IFI Accreditation may also be a condition of funding in some instances.

A standard paragraph for use in tender documentation is available from the IFI.

All fitness facilities in England should aim for full accessibility. IFI Mark accreditation should be the goal for all new and refurbished centres. The Mark is applicable to all fitness facilities regardless of sector and greatly increases the size of the market able to be targeted by a fitness suite.

IFI Mark accreditation should be considered by all fitness facilities in the UK wishing to become more inclusive and may be a condition of funding in some instances. It is applicable to all fitness facilities regardless of sector and greatly increases the size of the market able to be targeted by a fitness suite.

Equipment

The IFI requires the following for CV equipment:

For facilities aiming for Provisional Level IFI Mark Accreditation:

- 1 IFI accredited treadmill
- 1 IFI accredited upright or recumbent cycle
- 1 IFI accredited upper body ergometer

For facilities aiming for Registered Level IFI Mark Accreditation:

- Minimum 30% of all treadmills IFI accredited
- Minimum 30% of all upright and recumbent cycles IFI accredited
- 1 IFI accredited upper body ergometer

For facilities aiming for Excellent Level IFI Mark Accreditation:

- All treadmills IFI accredited
- All upright and recumbent cycles IFI accredited
- Minimum 1-2 IFI accredited upper body ergometer (depending on size of facility)
- Minimum 1 IFI accredited rowing machine and postural support seat

The IFI requires the following for resistance equipment:

For facilities aiming for Provisional Level IFI Mark Accreditation:

- 1 IFI accredited leg extension or leg press
- 1 IFI accredited leg curl
- 1 IFI accredited upper body multi-station (or equivalent pieces of IFI accredited upper body resistance equipment)
- Some small equipment (e.g. low weight dumbbells, dynabands etc.) available

For facilities aiming for Registered Level IFI Mark Accreditation:

Addition of IFI Approved:

- Small equipment pack.

For facilities aiming for Excellent Level IFI Mark Accreditation:

Addition of IFI accredited:

- High / low pulley
- Chest press
- Shoulder press
- Seated row

(Cardiovascular and resistance could be combined to condense space depending on the layout and other features included)

Reception Desk

A staffed reception desk located at the entrance to the fitness suite will provide reassurance to new users and provide an orientation point for users having difficulties or those with questions.

If a reception desk is provided within the fitness suite, ensure that this is split-level and is at a height accessible to a wheelchair user or people of short stature.

Screening Area

Provide a separate room that is accessible to wheelchair users for use in pre-exercise screening. This room should be available to users who require privacy e.g. for taking medication.

Flooring

The use of a different colour walkway on the main thoroughfares through the fitness suite can greatly assist users with a visual impairment or learning difficulty.

Floors should be slip resistant and be free of tripping hazards. Floors should not contain thick carpet which could impede the progress of wheelchair users.

Should stairs be located within the fitness suite, alternative provision to stairs must also be provided (i.e. lift)

Mirrors

Mirrors should be carefully located within the fitness suite, and use of logos / manifestation at eye level to avoid confusion. Locate them solely in the free weights area (for technique purposes). Do not locate mirrors behind treadmills as this can be confusing for visually impaired users.

If using mirrors within the fitness suite, the use of some logos/ manifestations at eye level to both seated and standing users to indicate their presence to visually impaired users. Try to avoid glare from lighting onto mirrors.

Equipment Provision

Previously it was the exception rather than the rule for equipment in fitness gyms to be usable by disabled people. In many cases accessible equipment was located in a 'special' room away from the main fitness area and/or staff were not adequately trained to supervise use by disabled people. It is now accepted that all fitness equipment rooms must be accessible to everyone and that the equipment and its layout must reflect this inclusive approach.

Refer to the IFI Accreditation Mark standards on page 68.

Equipment Layout

Cardiovascular and resistance equipment should be kept separate. In larger facilities though, it may be possible to have a separate "circuit" area containing one of each piece of accessible equipment to aid the user and provide a set sequence that is easy to follow.

A minimum of 1.0m transfer space (ideally 1.5m) should be provided around all inclusive equipment to allow access for wheelchair users. Where more than one piece of equipment of a certain model is provided, at least one should have a 1.0m space (ideally 1.5m) to allow access.

A storage area should be allocated for small equipment (such as dynabands, hand and ankle weights etc.) along with space provided for their use.

Plinths should not be installed. If they are unavoidable, ensure that they are ramped at regular intervals and the ramps provide access to all equipment types. The edges of the plinth must be protected and contrast in colour to the surrounding floor.

Refer to IFI Mark accreditation standards on pages 67 - 68.

Stretch Area

If stretch charts are provided on the adjacent wall area, they should be easy to understand. The charts should not be laminated or printed on glossy paper as this can make them more difficult to read for users with a visual impairment. An alternative to using these charts should be made available, either in alternative formats or through instruction from fitness suite staff.

An area allocated for stretching / mat work should be provided. Mats should be contrasted in colour to the floor to prevent a trip hazard.

Rest Area

A chair should be provided within the fitness suite for users requiring a rest.

Water and Paper Towels

A water fountain accessible to wheelchair users should be provided within the fitness suite.

As a minimum, free drinking water must be available to users on request.

Paper towel dispensers (if used) should be located at a height accessible to wheelchair users.

Assistive Hearing System

Hearing aid systems such as Induction loops should be available within the fitness suite to aid communication for people with hearing impairments, especially during inductions and personal training.

Air Conditioning

Variable air temperature through air conditioning may be beneficial to users with Multiple Sclerosis.

Entertainment

If music is played within the fitness suite this

should not be obtrusive or played at an excessive level. The volume of the music should be adjustable so that it can be lowered during inductions/sessions for hearing impaired users.

If cardio-theatre is available within the fitness suite, consider also activating the subtitle feature on televisions for those with a hearing impairment.

Printed Material

Programme cards, Par-Q forms etc. should be available to users in alternative formats. Any short-term notices e.g. informing users of a one-off early closure, should be produced in an accessible format as possible, and policies should also be implemented to ensure that disabled members are informed by staff of this. Include positive inclusive images within the fitness suite.

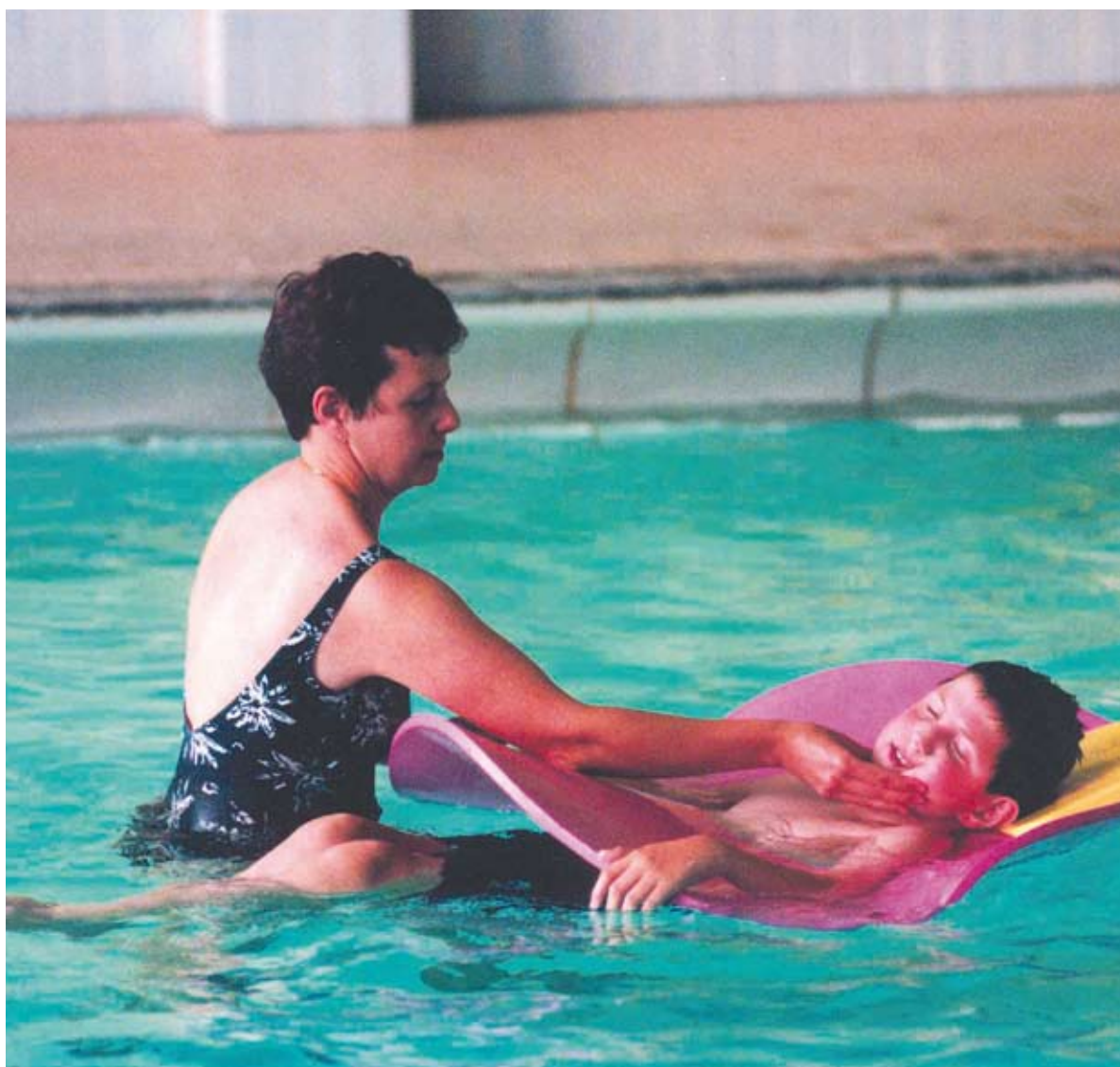

Goalball

Goalball is played by blind and partially sighted athletes. Each team has three players on the court at any one time and the object is to throw the ball into the opponents' goal. Bells inside the ball help to orient the players and indicate the direction of the oncoming ball. Therefore, while play is in progress the hall should be completely silent to allow the players to concentrate and react. All competitors wear masks whilst in play, allowing athletes with varying degrees of sight to participate together.

The court markings are normally of a temporary nature. For competitions all the court markings must be tactile but for less formal play only the orientation lines and the lines defining the team areas need to be tactile. The other lines should be visibly marked.

- The acoustic properties of the hall are critical to play. The hall should have a reverberation time not exceeding two seconds at mid-frequency, and should be designed and specified to avoid unnecessary background noise, for example from adjacent activities or equipment, or from nearby traffic.
- Tactile lines are formed by covering the builder's line or cord with 'Sportsline' or similar high-quality tape.
- The goals are 9.0m wide x 1.3m high and are usually made from sectional steel.



- The court size is 18.0m x 9.0m, the recommended minimum space is 21.0m x 30.0m with a clear height of 5.0m.
- The floor should have a smooth surface that allows the body to slide easily without jarring. See the Sport England guidance note 'Floors for Indoor Sports' and BS EN 14904.
- All wall surfaces should be flush with no projections or recesses.

Power-lifting

Additional space and/or convenient storage space should be provided for the specialist power-lifting bench.

Sailing

People with a wide range of disabilities enjoy sailing. The Royal Yachting Association's (RYA) Sailability programme promotes sailing as an ideal sport for disabled people. The key accessibility issues for sailing other than accommodation and management, which are common to all sports, are as follows:

Entrance gate

Sailing clubs often use security barriers or gates at the entrance to the facility. The design and management of the gate needs careful consideration so that it does not become a barrier to people who need to operate it. There is no easy solution but the problem can be reduced by

thoughtful management and by careful design including:

- Providing clear signs and contact numbers.
- Ensuring that the gate swings easily.
- Positioning controls and locks in easily accessible locations.

Car parking

Land is at a premium at marinas, particularly land close to the water. Wherever possible, however, dedicated accessible car parking spaces should be provided close to the clubhouse and moorings. Only where this is not possible is a drop-off point an acceptable alternative. An effective solution is the use of a golf buggy to convey disabled people from a 'remote' car park to the clubhouse and water. The buggies can also be used to move the dinghies around allowing improved access and added value.



Pontoons

- The main walkways should be at least 2m wide so that two wheelchairs can pass safely.
- Berthing pontoons should be rigid to avoid whiplash and a minimum of 1m wide between the cleats.
- At least one berthing pontoon, serving 5% of berths, should be fitted with a hoist and multiple sockets to allow full use of the pontoon.
- Pontoons should be finished with a non-slip surface.
- The junctions between sections of the pontoon should be flush.
- The edge of the pontoon should be a margin in contrasting colour. Cleats, service points, etc should be located within this margin.

Except where linking to a pontoon, the gradient of slopes should comply with the guidance provided earlier in this document.

In tidal situations and where it is unavoidable, safe access to pontoons may have to be restricted to times that suit the tide.

Ramps

- All ramps must be fitted with a slip-resistant surface. If slats are used across the ramp they must not be used for the whole width at right angles to the direction of travel to avoid creating a hazard for wheelchair users.
- All ramps should be fitted with handrails on both sides.
- Where it is not possible to gain access to the water using a suitable ramp, a proprietary lifting platform should be installed. Further details are available from RYA Sailability. It is important that such installations comply with all safety regulations and are properly maintained.

Slipways

- All slipways should be fitted with a winch system for the launch and recovery of boats.
- Slipways should be no steeper than 1 in 15.

Race hut

- The race hut should be accessible to everyone.

Shooting

- For shooting, the provision of convenient and secure storage for the shooting stands may be needed. These are often used as aids by some participants.



17.0 Wheelchair Sports

Wheelchair sports include athletics, badminton, basketball, bowls, fencing, rugby, table tennis and tennis. Wheelchair sports are developing very quickly. Many of them are fast moving and have developed specialist 'sports chairs'. These sports share many common facility issues:

- Some athletes find sitting in a sports chair for long periods uncomfortable and often only use the chairs during the sporting activity. It is therefore necessary to make provision for the secure storage of chairs while they are not in use to avoid them becoming a hazard.
- Sports wheelchairs are wider than wheelchairs used for everyday mobility. It is therefore necessary to ensure that lift car sizes are large enough to accommodate them, see Section 5.0 above and Tables 6 and 7.
- Specialist sports chairs can vary in width from 0.8m up to 1.2m depending on the seat width required for the individual and on the degree of wheel camber required, appropriate for the level of play.



The modern sportschair is purpose-built for the individual and the sport. Sportschairs are as highly engineered as other modern sports equipment

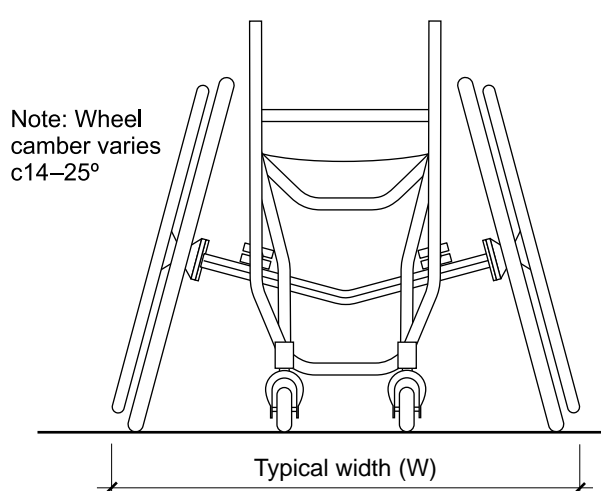
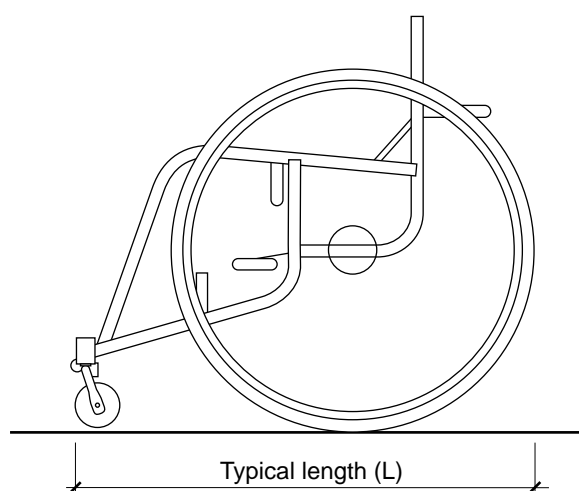

	Approximate length (L)	Approximate width (W)
Sportschairs generally	800	800 - 1200
Tennis chairs	850	1000
Racing chairs	1800	750

Note: These are approximate unoccupied sizes

Note: All dimensions are in millimetres

Table 12 Typical dimensions for sportschairs

Currently the majority of sports chairs are up to 0.85m in width and require a minimum effective clear door opening width of at least 0.875m and the larger chairs require a minimum clear effective width of 1.2m (see Table 5).

- When designing most sports facilities (see Table 5) the approach is to ensure that the majority of sports chair users can access any part of the building when they are using their sports chair and therefore it is essential that they should only have to negotiate/open a single door with a clear effective width of 0.875m i.e. they do not have to open 2 doors at the same time to pass through.
- There will be people who use sports chairs over 0.85m wide and the design approach is to consider the large sports chair as a piece of sports equipment and therefore the user will not be using it in all areas of the sports facility and a 'sports chair' zone needs to be defined and agreed with key stakeholders (see page 9).

The 'sports chair' zone will provide door openings that can achieve at least a 1.2m clear effective width and appropriately designed circulation spaces (see Figure 7)

- In most cases the 'sports chair' zone will be limited to the areas required to enter the building and use the specific sports facility. It is likely that in most cases the 'sports chair' zone will not include the changing and toilet provision. However, the extent of access for the larger sports chairs to individual or team changing and toilet facilities needs to be decided at the briefing stage for the project.



- Barriers, fencing and balustrades must be designed so that they do not obscure play for spectators who are wheelchair users.
- Floodlight meters/controls should be located within reach at an accessible height.
- There should be no hazardous projections into the playing area.

Athletics (indoor and outdoor)

- All sports surfaces, including synthetic track and field surfaces, must be designed and installed to meet the needs of disabled athletes and particularly those who are wheelchair users. This includes warm-up and warm-down areas. The sports surfaces should be well illuminated and have defined colours and textures to aid athletes with visual impairment.
- All athletics facilities, indoor and outdoor, should be fully accessible.
- Adequate, secure and convenient storage must be provided for sports chairs and wheelchairs.
- Where necessary provide removable kerbing for the track edge to allow access for wheelchair users and equipment.
- Ensure that sufficient space for access is provided around the track.
- The facility should include designated areas where technicians, competitors and coaches can repair and maintain sports chairs, other mechanical sports aids, equipment and prostheses etc.
- Racing chairs can be up to 2.0m long and manoeuvring space must be allowed for.
- Provide anchorage points in throwing areas to secure throwing frames. Ensure that there is convenient storage for throwing frames.



Badminton

Wheelchair badminton is played in accordance with the rules of the parent game except for a modification to the overall playing area. This is based around the standard badminton court with modifications to suit the particular disability of the people playing.

Basketball

Wheelchair basketball is one of the oldest wheelchair sports and, like its parent sport, is very vigorous and fast moving. It is played on a full-size basketball court and it is essential that the minimum margins around the court are maintained for the safety of the players and, where appropriate, spectators.

- Wall-mounted baskets should not be used.
- Mobile supports should have a cantilevered arm that maintains the overrun distance.
- In large venues designed for major competitions provide four team-changing rooms, each with two fully equipped accessible toilets. These venues must also provide wider corridors to allow two wheelchairs to pass.
- Wooden floor surfaces give the fastest game. Cushioned floors do not provide a suitable surface for wheelchair basketball as they significantly reduce the mobility of the sports chair. See the Sport England guidance note 'Floors for Indoor Sports' and BS EN 14904.

Bowls

Bowls can be played both indoors and outdoors with all players on equal terms. The two key issues are ensuring that access to the green is available for people in wheelchairs and ensuring that the playing surface is not damaged.

Access to the green

Safe and convenient access to the green must be provided. This can be achieved in two ways:

- The green should incorporate an edge detail that can be manually adjusted to bridge the ditch and provide a smooth transition onto the green for disabled people. This type of arrangement should always be available for indoor facilities.
- Outdoors, where it may not be practicable to provide an appropriate edge detail, a proprietary lightweight set of movable ramps should be provided to give direct access to the green. Provision should be made for the convenient and safe storage of these ramps when not in use.

Protecting the playing surface

To protect the playing surface special approved wheelchairs or buggies with wider wheels than the standard are used. Some players will have their own buggy but many will not. Players can also purchase clip-on wheels for use with their personal wheelchair while on the green.

- Management should provide two sizes of buggy.
- Provision should be made for the secure and convenient storage of bowls buggies and players' wheelchairs. Note that these buggies require a clear width of 0.875m, therefore door widths should be appropriately sized to allow such access through a single door leaf.

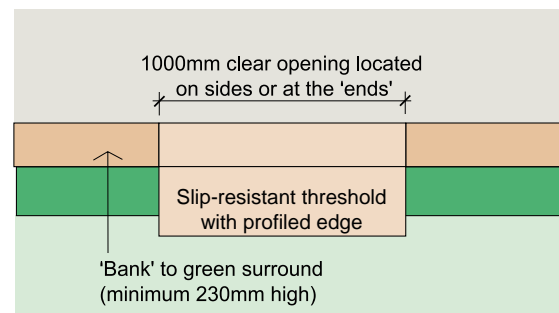

Plan

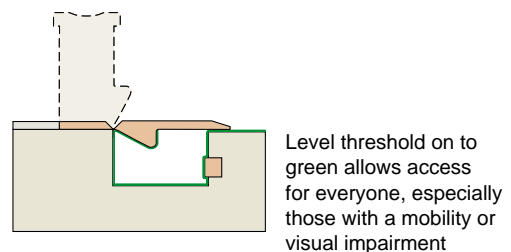
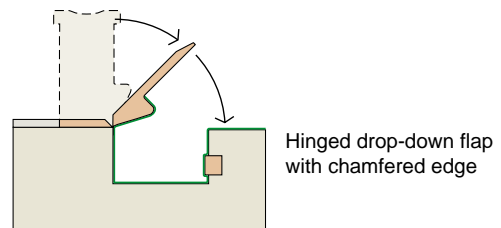
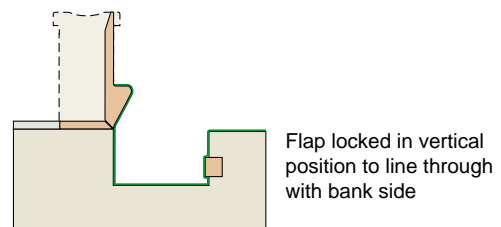

Figure 30 Typical sections through side or end ditch

Cricket

Wheelchair cricket is played indoors and outdoors. Teams of 6–11 players compete using the same rules as the parent sport. Indoors the game is played in a sports hall or cricket school. The minimum space required is a netted area of two lanes, although a larger space is preferred.

- All indoor cricket schools should make provision for wheelchair cricket.
- Ensure that the minimum circulation widths are maintained. Particular care should be taken to

ensure that net supports and fixings do not impinge on the circulation areas.

- Ensure that wheelchair users can gain access to the cricket net areas.

Fencing

There are no special requirements for wheelchair fencing apart from special frames that are used to secure the chairs in the correct relationship. The building design should ensure that:

- There is adequate secure storage provision immediately adjacent.
- Appropriately placed power supply points are available (minimum four double sockets).

Rugby

Wheelchair rugby – played in 20 countries – is a team sport for people with paraplegia and people with upper limb impairment.

The sport is played with a volleyball on a standard basketball court with goals and key areas marked out at both ends. The object of the game is to score by carrying the ball over your opponent's line. Most chair-to-chair contact is allowed, but not body contact.

Table Tennis

Table tennis is one of the sports that wheelchair users can play competitively against non-disabled opponents and many wheelchair users are members of table tennis clubs.

- Only tables that are free from obstructing cross-members should be used.
- Ensure that the proposed layout of tables/screens and netting does not hinder access between tables.
- To compensate for being seated while playing some wheelchair users use a higher than normal chair.

Tennis

Wheelchair tennis is one of the fastest growing sports for disabled people and is played in over 70 countries throughout the world. It provides the opportunity for disabled people to enjoy tennis both recreationally and / or competitively against non-disabled and disabled people of all ages.

Wheelchair tennis is played according to the rules of the parent sport except that the ball is allowed to bounce twice. Facility requirements (indoor and outdoor):



- Standard tennis court – most surfaces are suitable.
- Tennis wheelchairs can require up to 1.2m clear width along route ways.

The following are appropriate surfaces for wheelchair use:

- Acrylic – considered to be the best surface.
- Macadam.
- Clay – not new courts.
- Carpet.
- Some artificial grass surfaces – but these are generally unpopular with players because they are considered to be 'hard work'.

As a minimum provision, a facility with more than five courts should have at least two acrylic or macadam courts. When setting out new courts, allow for the maximum run back recommended by the Lawn Tennis Association. It is essential that adequate access be provided. This includes:

- Providing access around the court to change ends easily.
- Ensuring that the net posts on adjacent courts are not too close together for sports chair users to pass.
- Ensuring that floodlighting columns do not restrict the minimum width required.

18.0 Access In The Countryside

Projects aimed at making the countryside more accessible to disabled people must start with the general principles already outlined in this document. The designer should try to make the facility as convenient and safe as possible for all users. The key requirements are:

- Firm, even walking surfaces that do not become soft or slippery when wet.
- Easy ramps and steps.
- Handrails and grab rails at hazardous locations.
- Paths and gates that are wide enough for wheelchair users.
- WCs within easy reach.
- Clear signposting.
- Tactile direction signs.
- Auditory aids (public address and induction loops).

Close attention should be paid to:

- Alighting from and parking a bus.
- Finding and using a WC.
- Finding and approaching the entrance.
- Buying a ticket.
- Passing through/around a turnstile.
- Getting to the destination.

The designer should consider how all of these events will impact on a disabled user, and then make the necessary adjustments. See the Fieldfare Trust 'Countryside for All' Project. (www.fieldfare.org.uk)



19.0 Conclusion

As stated in the introduction, this guidance is not about 'special provision' or what a disabled person cannot do because of an impairment or a medical condition. This document is written from the view that it is the design or management of a facility that creates the barriers and limitations to use by disabled people. Everyone is entitled to equal opportunities to participate in sport, and to do so in high quality facilities that are attractive, well designed and properly managed.

By following the minimum requirements set out in this guidance note and the others in the series, inclusive design can be achieved that will benefit everyone. As well as being equitable, it makes financial sense to attract rather than discourage all potential customers, together with their friends and families, to use sports facilities. Sports facilities should be available for everyone to use.

19.0 Contact Addresses

British Blind Sport

Pure Offices, Plato Close, Tachbrook Park
Leamington Spa, Warwickshire CV34 6WE
Tel: 01926 424247
Fax: 01926 427775
www.britishblindsport.org.uk

British Disabled Fencing Association

32 Devonshire Way, Croydon, Surrey
CR0 8BR
www.bpfa.org.uk

British Disabled Water Ski Association

The Tony Edge National Centre, Heron Lake, Hythe
End Road, Wraysbury, Nr Staines TW19 6HW
Tel: 01784 483664
Fax: 01784 482747
www.bdwsa.org

British Paralympic Association

60 Charlotte Street, London W1T 2NU
Tel: 020 7842 5789
Fax: 020 7842 5777
www.paralympics.org.uk

British Wheelchair Sports Foundation

WheelPower, Stoke Mandeville Stadium,
Guttmann Road, Stoke Mandeville,
Buckinghamshire HP21 9PP
Tel: 01296 395995
Fax: 01296 424171
www.wheelpower.org.uk

Centre for Accessible Environments

Centre for Accessible Environments and the
Access Lab
70 South Lambeth Road
London SW8 1RL
Tel/Minicom: 020 7840 0125
Fax: 020 7840 5811
www.cae.org.uk

English Federation of Disability Sport

Manchester Metropolitan University, Alsager
Campus, Hassall Road, Alsager, Stoke-on-Trent
ST7 2HL
Tel: 0161 247 5294
Minicom: 0161 247 5644
Fax: 0161 247 6895
www.efds.co.uk

Equality and Human Rights Commission

3 More London, Riverside Tooley Street, London
SE1 2RG
Tel: 020 3117 0235 (non helpline calls only)
Fax: 0203 117 0237
www.equalityhumanrights.com

Great Britain Boccia Federation

GB Boccia Federation c/o ParalympicsGB
60 Charlotte Street, London W1T 2NU
Tel: 0207 842 5785
www.gb-boccia.org

Guide Dogs for the Blind Association

Burghfield Common, Reading RG7 3YG
Tel: 0118 983 5555
Fax: 0118 983 5433
www.guidedogs.org.uk

Inclusive Fitness Initiative

MLS Ltd., 4 Park Square, Newton Chambers Road,
Thornclyffe Park, Chapelton, Sheffield, S35 2PH
Tel: 0114 257 2060
Textphone: add prefix 18001
Fax: 0114 257 0664
www.inclusivefitness.org

JMU Access Partnership

Joint Mobility Unit, 105 Judd Street, London,
WC1H 9NE
Tel: 0207 391 2002
Fax: 020 7387 7109
www.jmuaccess.org.uk

RADAR – the Disability Network

12 City Forum, 250 City Road,
London EC1V 8AF
Tel: 020 7250 3222
Minicom: 020 7250 4119
Fax: 0870 141 0337
www.radar.org.uk

Riding for the Disabled Association

Norfolk House, 1a Tournament Court, Edgehill
Drive, Warwick CV34 6LG
Tel: 0845 658 1082
Fax: 0845 658 1083
www.riding-for-disabled.org.uk

Royal National Institute of Blind People

105 Judd Street, London, WC1H 9NE
Tel: 020 7388 1266
Fax: 020 7388 2034
www.rnib.org.uk

Royal National Institute for Deaf People

19–23 Featherstone Street, London EC1Y 8SL

Tel: 020 7296 8000

Textphone: 020 7296 8001

Fax: 020 7296 8199

www.rnid.org.uk

The Sign Design Society

The Sign Design Society, 5 Longton Grove,
Sydenham, London SE26 6QQ

Tel: 020 8776 8866

Fax: 0871 900 3160

www.signdesignsociety.co.uk

United Kingdom Sports Association for People with Learning Disability

First Floor, 12 City Forum, 250 City Road,

London EC1V 2PU

Tel: 020 7490 3057

Fax: 020 7251 8861

www.uksportsassociation.org



Alternative Languages and Formats:

This document can be provided in alternative languages, or alternative formats such as large print, Braille, tape and on disk upon request. Call the Sport England switchboard on 08458 508 508 for more details

Information Prepared By:

Sport England, Brian Towers and S&P Architects

Acknowledgements:

Sport England is indebted to the individuals and organisations that have contributed to this guidance note with excellent advice, information and photographic material. In particular (in alphabetical order):

Brian Towers - The Access Consultancy
English Federation of Disability Sport
GLR Architects
Inclusive Fitness Initiative
Jane Simpson
Julie Fleck

London Sports Forum for Disabled People
Olympic Delivery Authority Built Environment Access Panel
Robin Wilson Consulting
Sue Pease
Tom Lister

Photography by:

Della Batchelor
Alan Edwards
Charlie Fawell
Eileen Langsley
Robynne Limoges

David Slater
Richard Sowersby
RGK Wheelchairs
S&P Architects
Charlotte Wood

Disclaimer:

Amendments, alterations and updates to this document may take place from time to time. When using Sport England Design Guidance you should always download the documents at the time of use in order to ensure that you are referring to the most up-to-date information. The term Design Guidance should be taken to imply the minimum standards required to produce best practice solutions acceptable to Sport England.

This document is for information only. Whilst every effort has been made to ensure the accuracy of this Design Guidance Note and all information contained herein, Sport England, or its agents, shall not be held responsible or liable to any party in respect of any loss, damage or costs of any nature arising directly or indirectly from reliance placed on this information. The views expressed are not intended to take away or diminish the responsibility of the user to comply with current or future legislation and if there are any conflicts between the views expressed in this document and legislation, the latter takes precedence.

Issue Tracker:

003 – Minor Amendment to Page 29: April 2010
002 – Updated and Amended Publication: March 2010
001 – Initial Publication: November 2002

Sport England

3rd Floor Victoria House
Bloomsbury Square
London
WC1B 4SE

Tel : +44 (0)8458 508 508
Fax: +44 (0)20 7383 5740
Email: info@sportengland.org
Web: <http://www.sportengland.org>

© Sport England, April 2010

This guidance is supported by:

